

- C Cromo lucido  
Bright Chrome
- T Cromo satinato  
Satin Chrome
- B Bronzo  
Bronze
- 85 Bronzo satinato  
Satin Bronze
- L Ottone lucido  
Bright Brass
- 2 PVD Ottone  
PVD Brass
- II Inox satinato  
Stainless steel
- 9 Oro anodizzato  
Anodized Gold
- 6 Argento anodizzato  
Anodized Silver

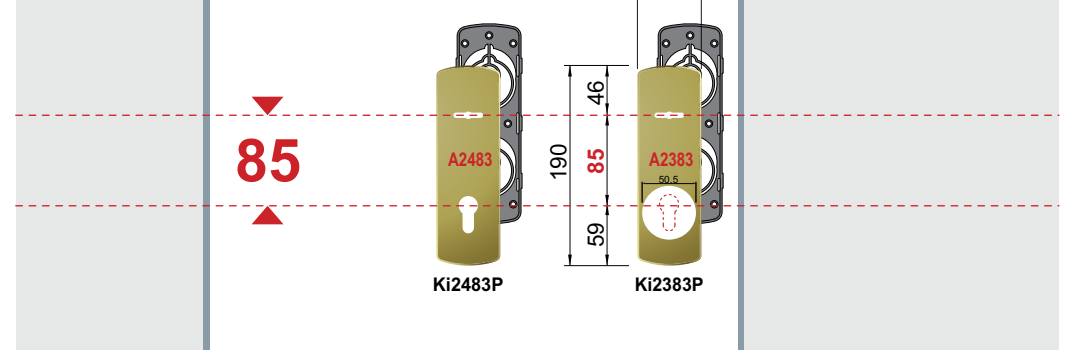

FINITURE / FINISHES

- |                                    |                                      |   |
|------------------------------------|--------------------------------------|---|
| (C) Cromo lucido<br>Bright Chrome  | (BS) Bronzo satinato<br>Satin Bronze | (II) Inox satinato<br>Stainless steel     |
| (T) Cromo satinato<br>Satin Chrome | (L) Ottone lucido<br>Bright Brass    | (9) Oro anodizzato<br>Anodized Gold       |
| (B) Bronzo<br>Bronze               | (2) PVD Ottone<br>PVD Brass          | (6) Argento anodizzato<br>Anodized Silver |

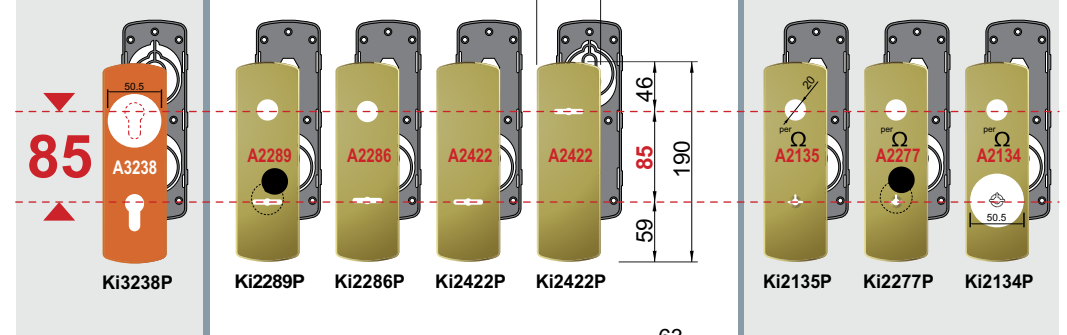
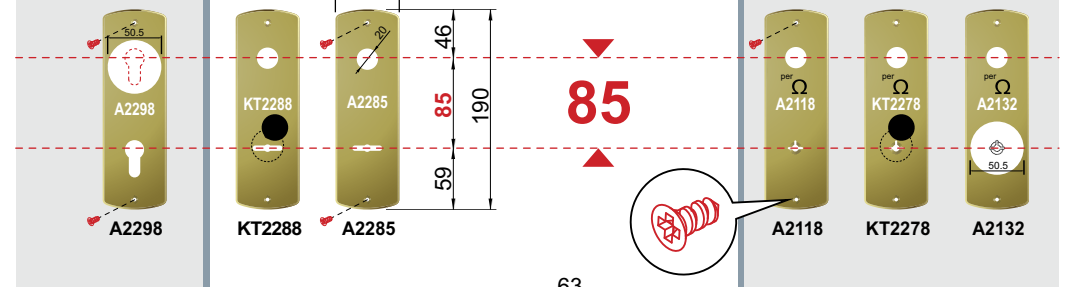
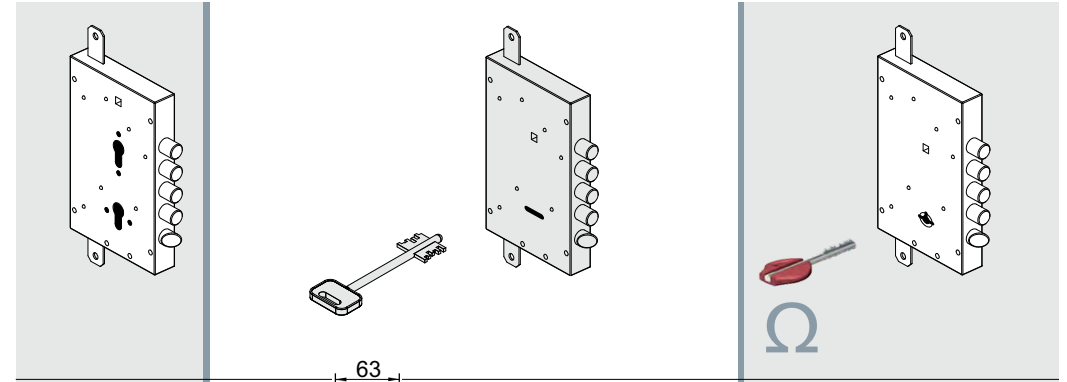
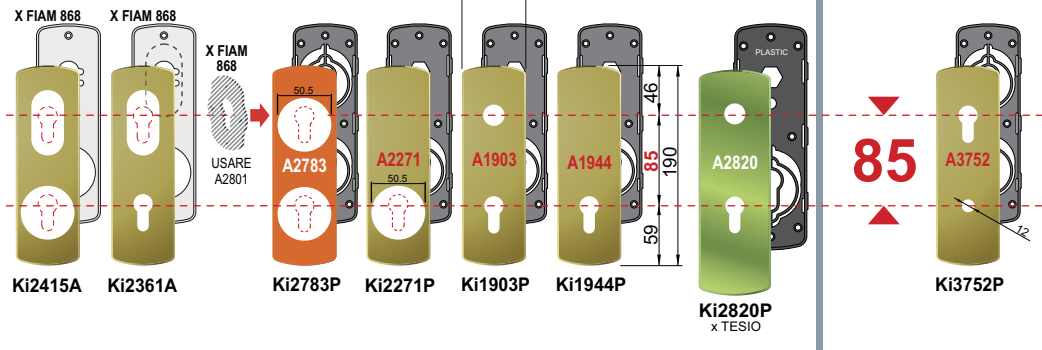
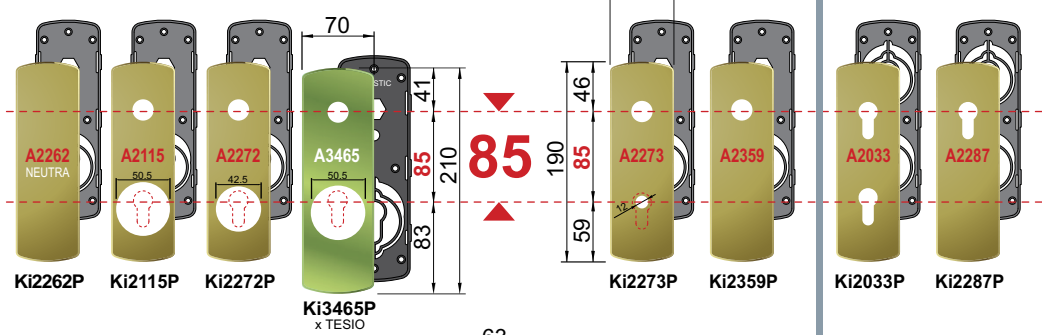
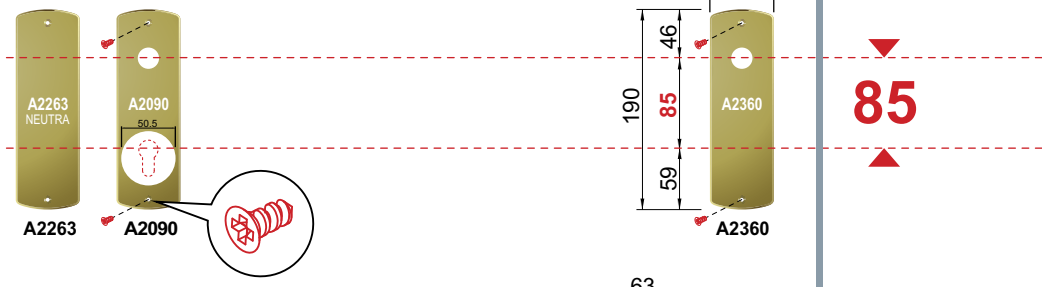
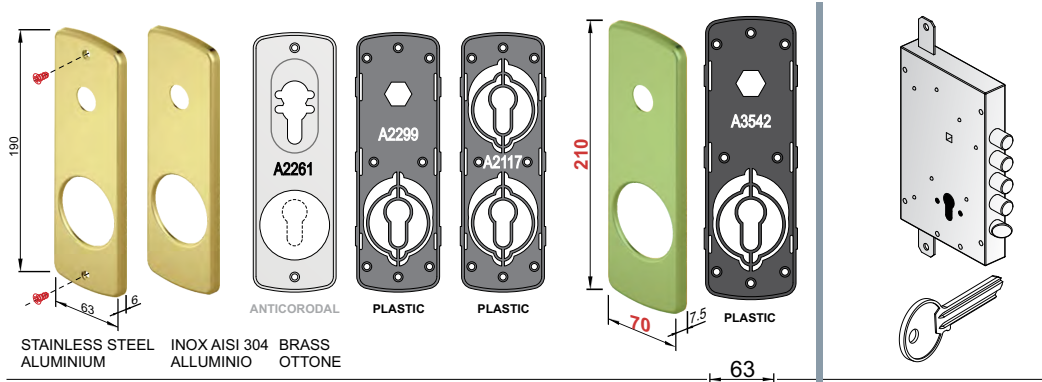
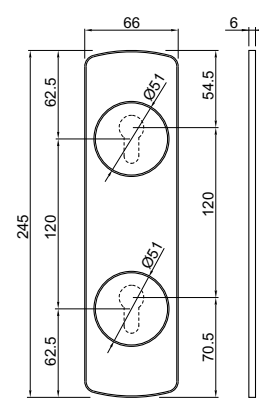
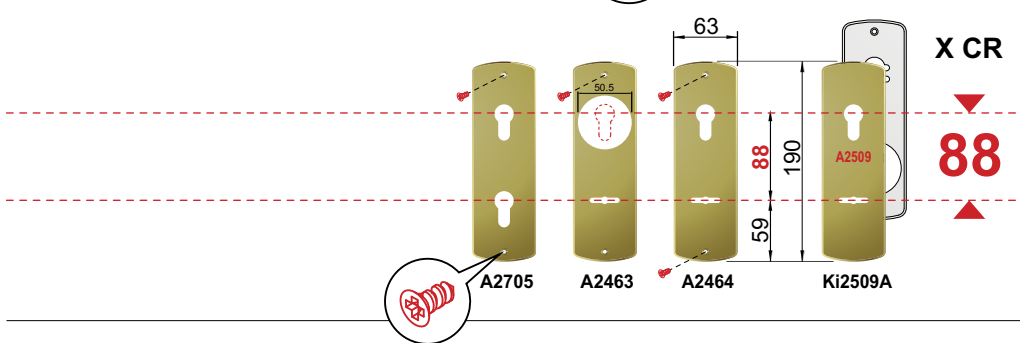
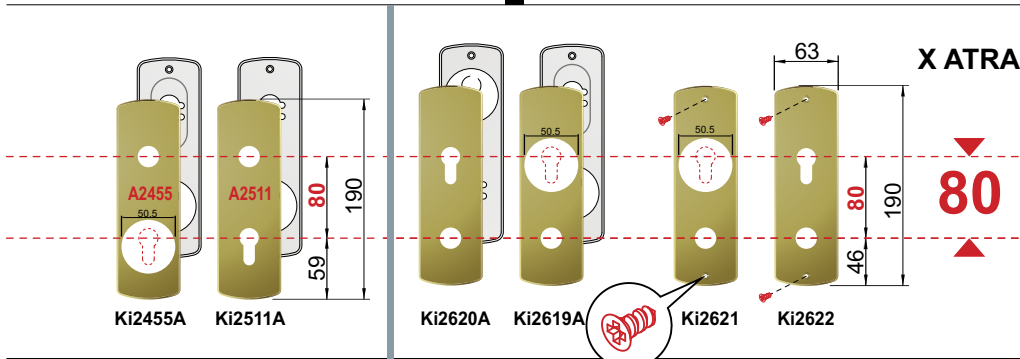
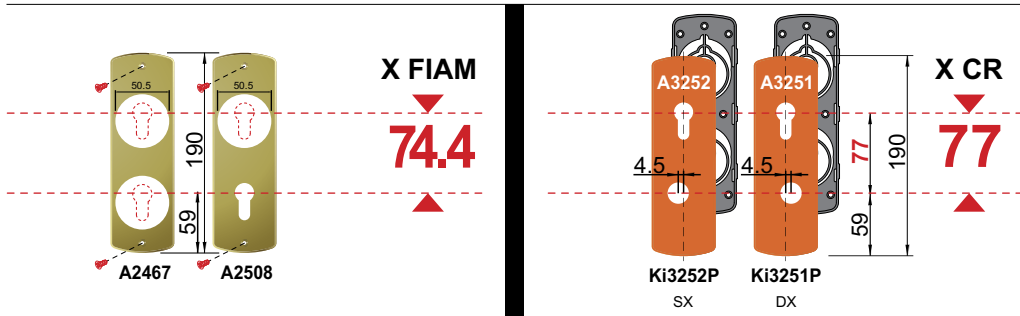
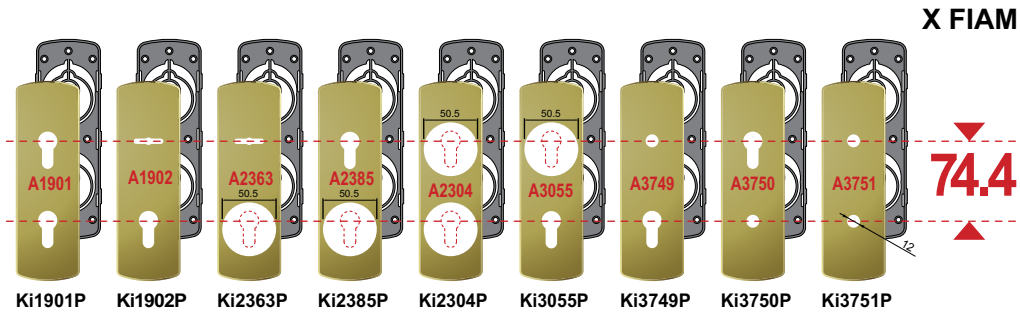
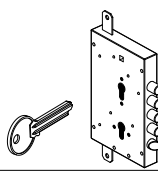

Ki3771P Ki3772P Ki3773P



Ki3803P Ki3774P Ki3775P Ki3776P



Ki3777P Ki3778P Ki3779P

- FINITURE FINISHES
- |                                    |                                      |   |
|------------------------------------|--------------------------------------|---|
| (C) Cromo lucido<br>Bright Chrome  | (BS) Bronzo satinato<br>Satin Bronze | (II) Inox satinato<br>Stainless steel     |
| (T) Cromo satinato<br>Satin Chrome | (L) Ottone lucido<br>Bright Brass    | (9) Oro anodizzato<br>Anodized Gold       |
| (B) Bronzo<br>Bronze               | (2) PVD Ottone<br>PVD Brass          | (6) Argento anodizzato<br>Anodized Silver |