

MONOLITO ROK SFERIK

PAT. PEND.



GRADO 4



MONOLITO

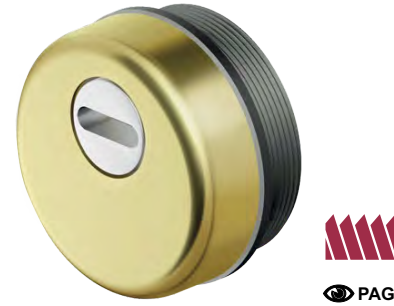

MONOLITO
88x68

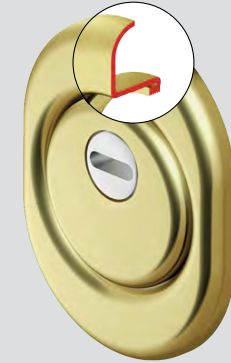

QUADRY
84x64

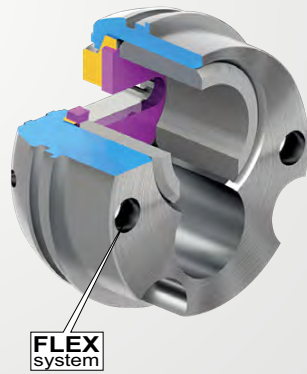
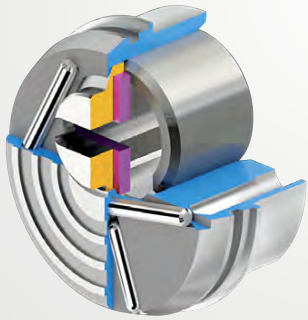
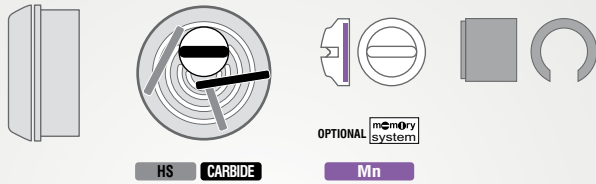

OPTIONAL
MEMORY SYSTEM

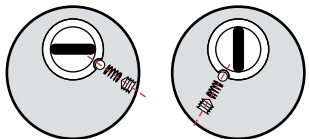

FLEX SYSTEM



5 VOLTE PIU' RESISTENTE DELLE VITI TRADIZIONALI 12.9

FILETTATO

 Ø50
 PAT. PEND.
SFERIK

X ATRA

H	20	MA2371	MA2372
25	25	MA2665	MA2731
35	35	MA1927	MA1928
45	45	MA2702	

X ATRA

H	20	MA2371..	MA2372..
25	25	MA2665..	MA2731..
35	35	MA1927..	MA1928..
45	45	MA2702..	

A2209.. H 20
A1561.. H 25/35/45

C	Cromo lucido
T	Bright Chrome
T	Cromo satinato
S	Satin Chrome
B	Bronzo
B	Bronze
Z	PVD Ottone
Z	PVD Brass
TT	Ottone satinato
TT	Satin Brass
BS	Bronzo satinato
BS	Satin Bronze
IT	Inox satinato
IT	Stainless steel

pag.

S1	3.5
D1	5

X ATRA

S1	3.5
D1	5

BD251 20 ..
BD251 25 ..
BD251 35 ..
BD251 45 ..
BD250 20 ..
BD250 25 ..
BD250 35 ..
BD250 45 ..

BD351 20 ..
BD351 25 ..
BD351 35 ..
BD350 20 ..
BD350 25 ..
BD350 35 ..

BD251W 20 ..
BD251W 25 ..
BD251W 35 ..
BD251W 45 ..
BD250W 20 ..
BD250W 25 ..
BD250W 35 ..
BD250W 45 ..

BD351W 20 ..
BD351W 25 ..
BD351W 35 ..
BD350W 20 ..
BD350W 25 ..
BD350W 35 ..

ESEMPIO DI CODICE PER VITI M8
EXAMPLE OF CODE FOR FIXING M8

BD251 20 ..
BD251 25 ..
BD251 35 ..
BD251 45 ..
BD250 20 ..
BD250 25 ..
BD250 35 ..
BD250 45 ..

BD351W 20 ..
BD351W 25 ..
BD351W 35 ..
BD350W 20 ..
BD350W 25 ..
BD350W 35 ..

FINITURE FINISHES

C	Cromo lucido
T	Bright Chrome
T	Cromo satinato
S	Satin Chrome
B	Bronzo
B	Bronze
Z	PVD Ottone
Z	PVD Brass
TT	Ottone satinato
TT	Satin Brass
BS	Bronzo satinato
BS	Satin Bronze
IT	Inox satinato
IT	Stainless steel

FILETTATO

 Ø50
 PAT. PEND.
SFERIK

X ATRA

H	20	MA2365	MA2367
25	25	MA2871	MA2052
35	35	MA2053	MA2054
45	45	MA2685	

X ATRA

H	20	MA2365..	MA2367..
25	25	MA2871..	MA2052..
35	35	MA2053..	MA2054..
45	45	MA2685..	

A2209.. H 20
A1561.. H 25/35/45

C	Cromo lucido
T	Bright Chrome
T	Cromo satinato
S	Satin Chrome
B	Bronzo
B	Bronze
Z	PVD Ottone
Z	PVD Brass
TT	Ottone satinato
TT	Satin Brass
BS	Bronzo satinato
BS	Satin Bronze
IT	Inox satinato
IT	Stainless steel

pag.

S1	3.5
D1	5

X ATRA

S1	3.5
D1	5

BD201 20 ..
BD201 25 ..
BD201 35 ..
BD201 45 ..
BD200 20 ..
BD200 25 ..
BD200 35 ..
BD200 45 ..

BD301 20 ..
BD301 25 ..
BD301 35 ..
BD300 20 ..
BD300 25 ..
BD300 35 ..

BDT251W 20 ..
BDT251W 25 ..
BDT251W 35 ..
BDT251W 45 ..
BDT250W 20 ..
BDT250W 25 ..
BDT250W 35 ..
BDT250W 45 ..

BDT351W 20 ..
BDT351W 25 ..
BDT351W 35 ..
BDT350W 20 ..
BDT350W 25 ..
BDT350W 35 ..

FINITURE FINISHES

C	Cromo lucido
T	Bright Chrome
T	Cromo satinato
S	Satin Chrome
B	Bronzo
B	Bronze
Z	PVD Ottone
Z	PVD Brass
TT	Ottone satinato
TT	Satin Brass
BS	Bronzo satinato
BS	Satin Bronze
IT	Inox satinato
IT	Stainless steel

FILETTATO

 Ø50
 PAT. PEND.
SFERIK

X ATRA

H	25	MA3817	MA3818
---	----	--------	--------

X ATRA

H	25	MA3817..	MA3818..
---	----	----------	----------

A2209.. H 20
A1561.. H 25/35/45

C	Cromo lucido
T	Bright Chrome
T	Cromo satinato
S	Satin Chrome
B	Bronzo
B	Bronze
Z	PVD Ottone
Z	PVD Brass
TT	Ottone satinato
TT	Satin Brass
BS	Bronzo satinato
BS	Satin Bronze
IT	Inox satinato
IT	Stainless steel

pag.

S1	3.5
D1	5

X ATRA

S1	3.5
D1	5

BDF201 25 ..
BDF200 25 ..

BDF251W 25 ..
BDF250W 25 ..

BDF301 25 ..
BDF300 25 ..

BDF351W 25 ..
BDF350W 25 ..

FINITURE FINISHES

C	Cromo lucido
T	Bright Chrome
T	Cromo satinato
S	Satin Chrome
B	Bronzo
B	Bronze
Z	PVD Ottone
Z	PVD Brass
TT	Ottone satinato
TT	Satin Brass
BS	Bronzo satinato
BS	Satin Bronze
IT	Inox satinato
IT	Stainless steel

SUPER TOP

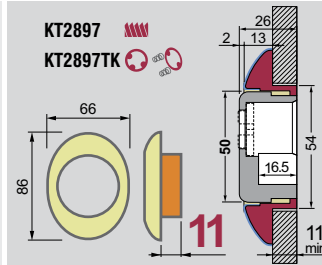
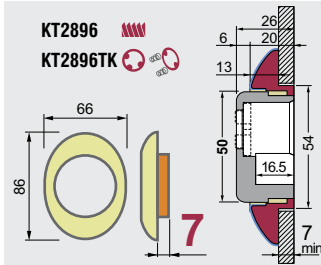

TOP

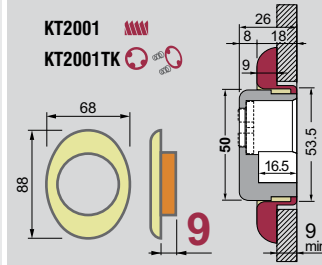
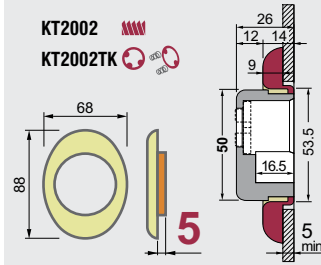

MONOLITO

OPTIONAL
A2073
SPESORE 5mm
SPACER 5mm
PAG

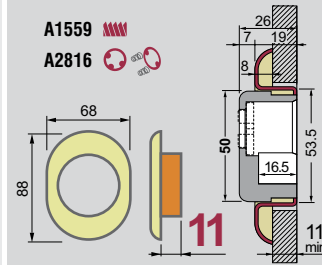
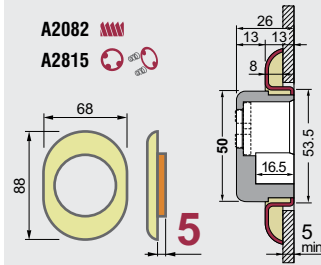

STONE

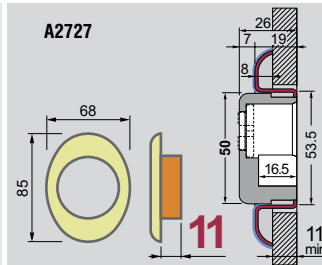
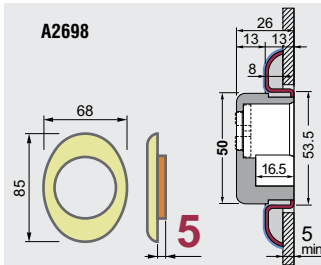

MILANO

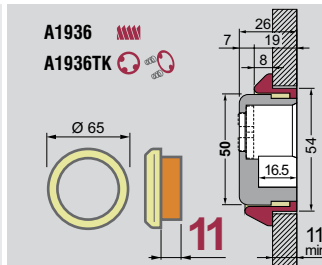
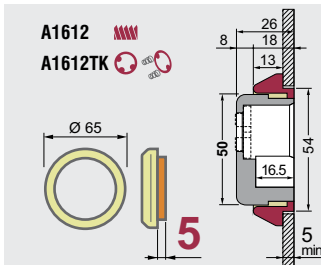

MONOLITO E

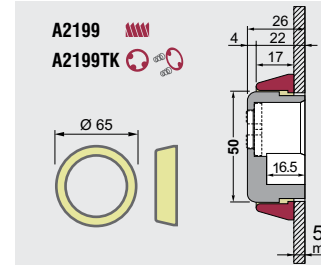

QUADRA

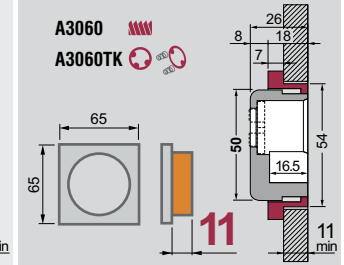
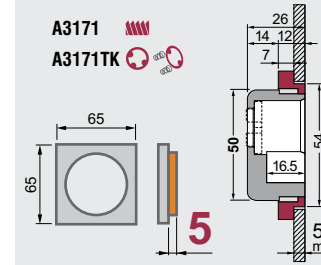

QUADRY

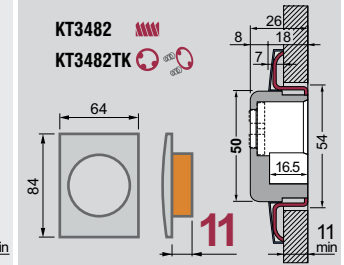
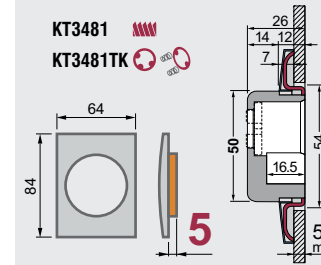

QUADRY P

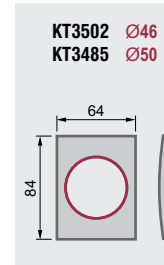

KUBO

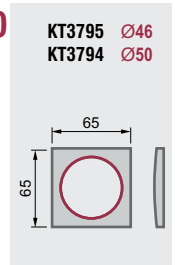

STANDARD

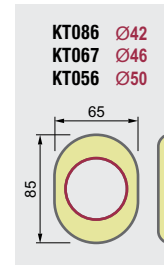

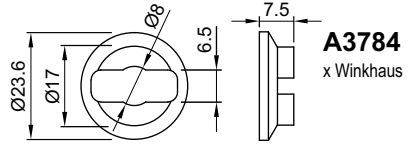
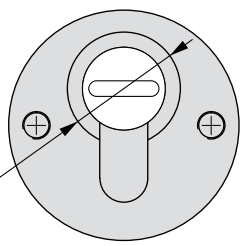

A3784
x Winkhaus

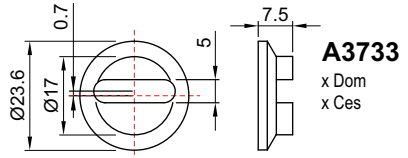

A3733
x Dom
x Ces

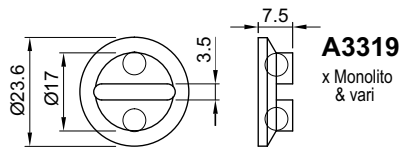

A3319
x Monolito
& vari

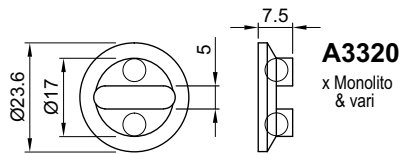

A3320
x Monolito
& vari

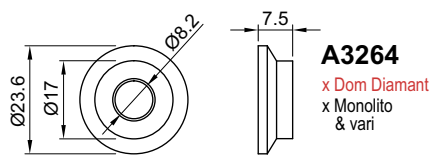

A3264
x Dom Diamant
x Monolito
& vari

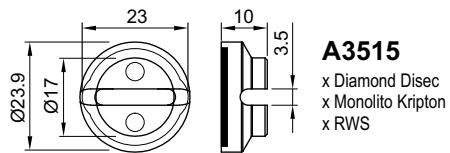

A3515
x Diamond Disec
x Monolito Krypton
x RWS

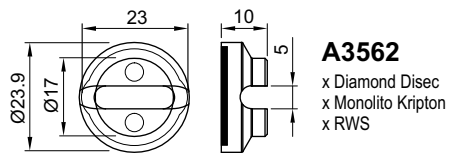

A3562
x Diamond Disec
x Monolito Krypton
x RWS

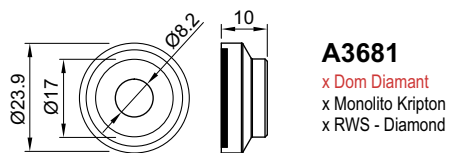

A3681
x Dom Diamant
x Monolito Krypton
x RWS - Diamond

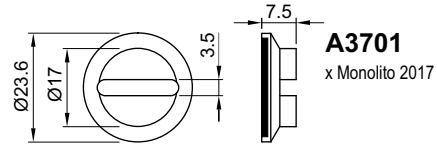

A3701
x Monolito 2017

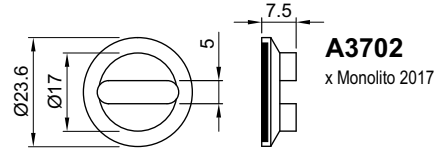

A3702
x Monolito 2017

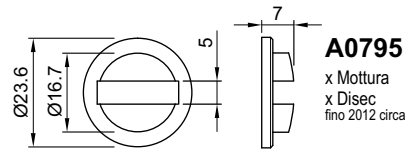

A0795
x Mottura
x Disec
fino 2012 circa

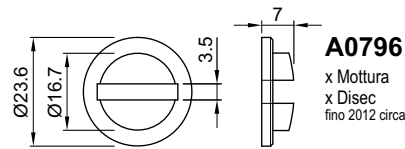

A0796
x Mottura
x Disec
fino 2012 circa

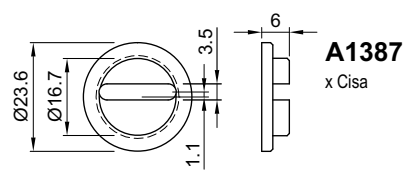

A1387
x Cisa

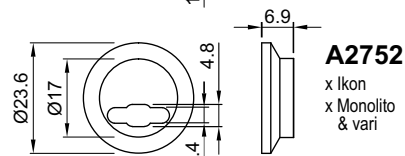

A2752
x Ikon
x Monolito
& vari

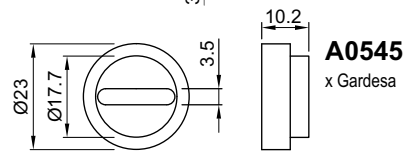

A0545
x Gardesa

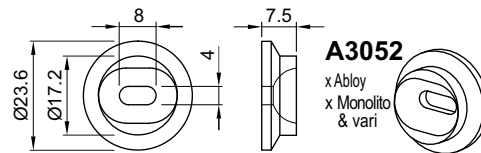

A3052
x Abloy
x Monolito
& vari

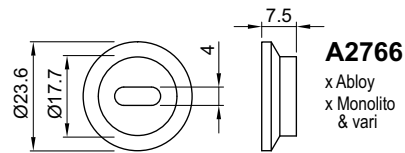

A2766
x Abloy
x Monolito
& vari

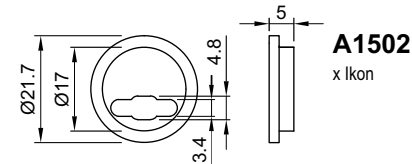
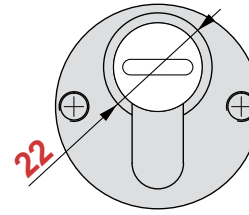

A1502
x Ikon

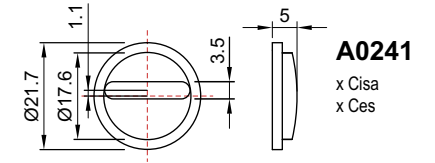

A0241
x Cisa
x Ces

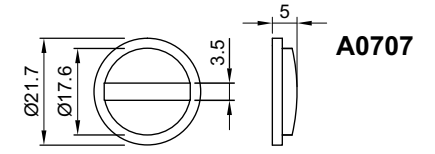

A0707

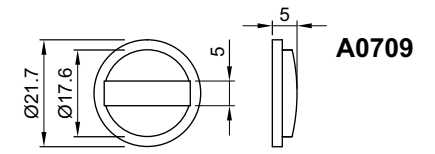

A0709

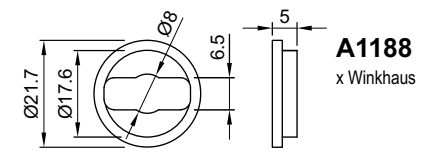

A1188
x Winkhaus

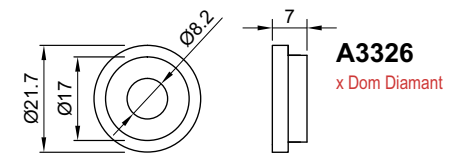

A3326
x Dom Diamant

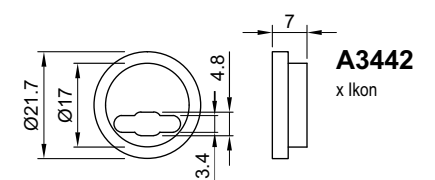

A3442
x Ikon

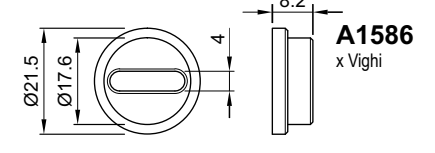

A1586
x Vighi

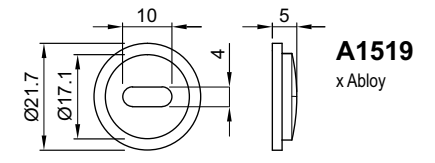

A1519
x Abloy



T

Cromo satinato
Satin chrome



iT

Inox satinato
Stainless steel



W

Bianco (RAL 9010)
White (RAL 9010)

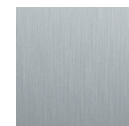

6

Alluminio silver
Silver aluminium



C

Cromo lucido
Polished chrome

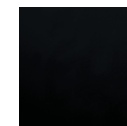

N

Nero
Black



9

Alluminio oro
Gold aluminium



L

Ottone lucido
Polished brass

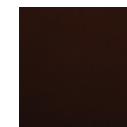

M

Marrone
Brown



A

Alluminio champagne
Champagne aluminium



BS

Bronzo satinato
Satin bronze



2

PVD ottone
PVD bright brass



TT

Ottone satinato
Satin brass



B

Bronzo
Bronze



SERVICE KIT
430x290x55 mm
ACCIAIO INOX SATINATO



SERVICE KIT mini
328x258x52 mm

18061205 20 pz Vite M6x120 testa svasata piana con cava esagonale CLASSE 10.9	18060705 20 pz Vite M6x70 testa svasata piana con cava esagonale CLASSE 10.9	10060405 10 pz Vite M6x40 testa cilindrica con cava esagonale CLASSE 12.9	28030052 20 pz Grano M3x5 con cava esagonale	25060065 20 pz Grano M6x6 con cava esagonale	25060405 20 pz Grano M6x40 con cava esagonale
18061005 20 pz Vite M6x100 testa svasata piana con cava esagonale CLASSE 10.9	18060605 20 pz Vite M6x60 testa svasata piana con cava esagonale CLASSE 10.9	10050405 10 pz Vite M5x40 testa cilindrica con cava esagonale CLASSE 8.8	31030125 100 pz Vite autofilettante Ø 3x12 testa svasata piana a croce BRONZO	31030125 100 pz Vite autofilettante Ø 3x12 testa svasata piana a croce ORO	
10061205 20 pz Vite M6x120 testa cilindrica con cava esagonale CLASSE 12.9	10060705 20 pz Vite M6x70 testa cilindrica con cava esagonale CLASSE 12.9	10080405 10 pz Vite M8x40 testa cilindrica con cava esagonale	31030125 100 pz Vite autofilettante Ø 3x12 testa svasata piana a croce ZINCATA	31040165 100 pz Vite autofilettante Ø 4x16 testa svasata piana a croce ORO	
10061005 20 pz Vite M6x100 testa cilindrica con cava esagonale CLASSE 12.9	10060605 20 pz Vite M6x60 testa cilindrica con cava esagonale CLASSE 12.9	13060200 10 pz Vite M6x20 testa tonda quadro sotto testa	30 pz Dadi esagonali M6	30 pz Rondella x M6	20 pz Sfera Ø 4,8 acciaio 10 pz A0716 Pin blocco SG 10 pz O-Ring Ø 41x1,78
10060805 20 pz Vite M6x80 testa cilindrica con cava esagonale CLASSE 12.9	10060505 20 pz Vite M6x50 testa cilindrica con cava esagonale CLASSE 12.9	A1566 10 pz Ø 50x2,5 Spessore universale	A2427N 12 pz Adattatore codolo (Nero)	A1056 10 pz Ø 40x2,5 Spessore universale	

18061205 10 pz Vite M6x120 CLASSE 10.9	10060805 10 pz Vite M6x80 CLASSE 12.9				
10061205 10 pz Vite M6x120 CLASSE 12.9	10061005 10 pz Vite M6x100 CLASSE 12.9				
A2578 10 pz Spessore m 8 Ø 50x2,5	18061005 10 pz Vite M6x100 CLASSE 10.9	10060705 10 pz Vite M6x70 CLASSE 12.9	10060605 10 pz Vite M6x60 CLASSE 12.9	10060505 10 pz Vite M6x50 CLASSE 12.9	
10 pz O-Ring Ø 41x1,78	A1566 10 pz Spessore universale Ø 50x2,5	10080405 10 pz Vite M8x40	31030125 4 pz Vite Ø 3x12 ORO	31030125 4 pz Vite Ø 3x12 BRONZO	31030125 4 pz Vite Ø 3x12 ZINCATA

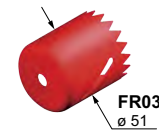
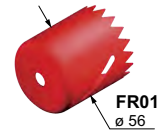
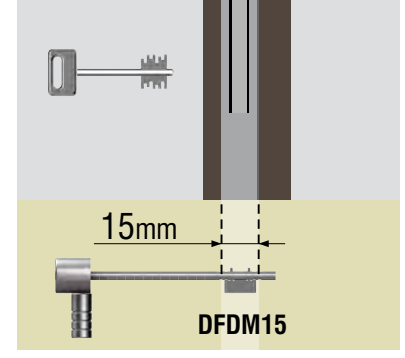
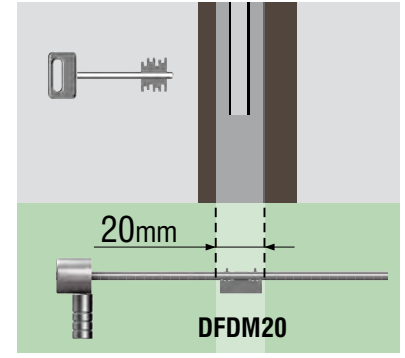
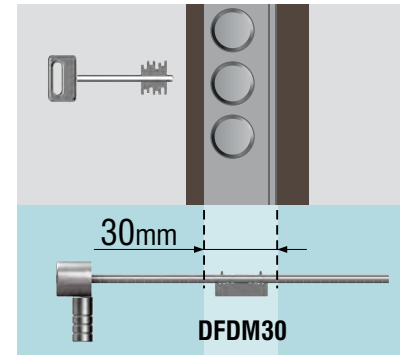
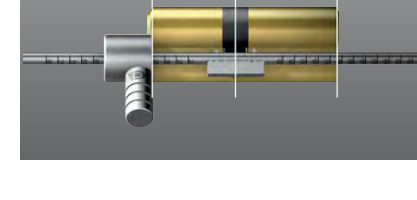
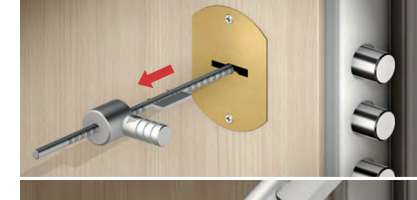
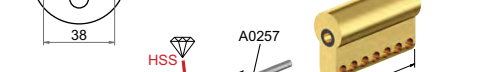
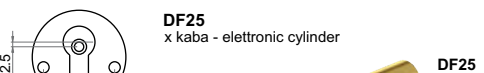
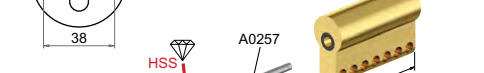
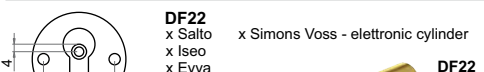
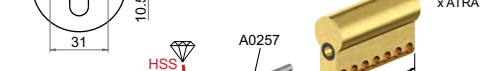
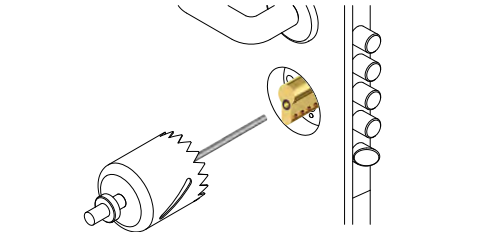
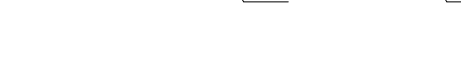
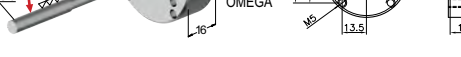
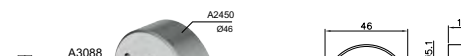
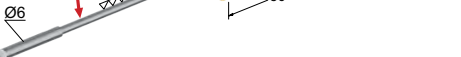
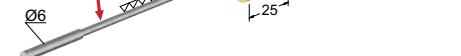
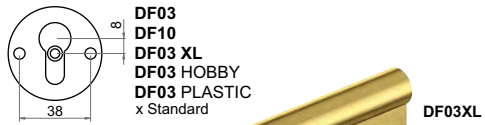

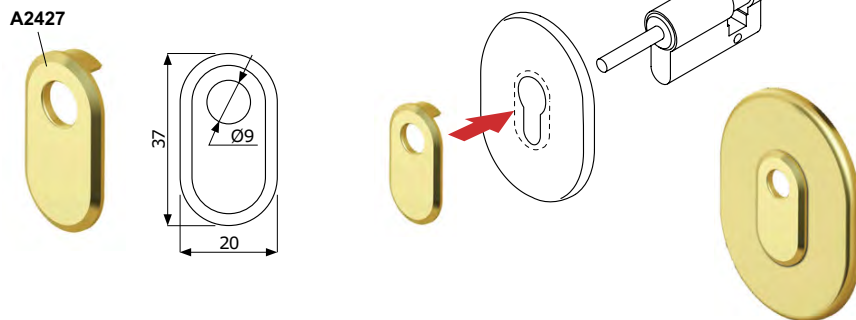
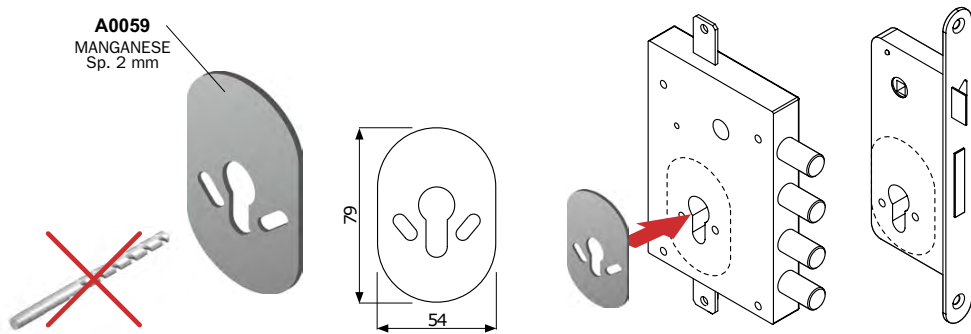
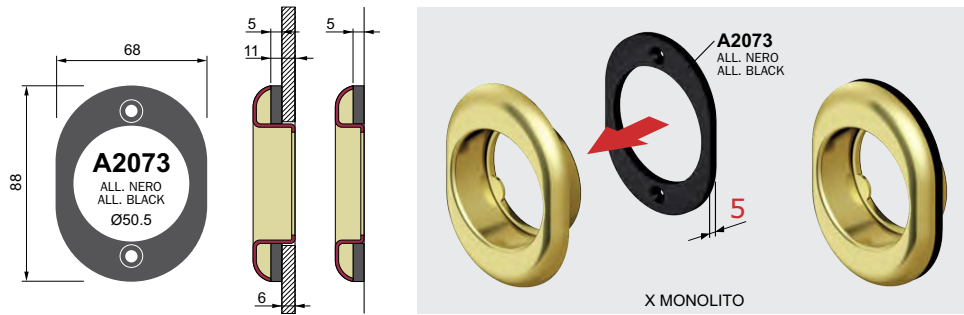

FINITURE / FINISHES

- C Cromo lucido / Bright Chrome
- B Bronzo / Bronze
- L Ottone lucido / Bright Brass
- T Cromo satinato / Satin Chrome
- N Nero / Black

Ø 50	UNIVERSAL		
	A1565 1mm		
	A1566 2mm		
	A2755 5mm		
	A2756 10mm		
	A2763 15mm		
Ø 45	A2578 2mm		
	X OMEGA		
	A3375 2mm		
Ø 44	X FIAM		
	A0592 1mm		
Ø 42	A0591 2mm		
	A2633 2mm		
Ø 40	A3185 5mm		
	X ESETY X ATRA X CR		

	L=43	10060435
	L=40	10080405
	L=40	10040405
	L=45	10040455
	L=50	10040505
	L=60	10040605
	L=70	10040705
	L=80	10040805
	L=40	10050405
	L=45	10050455
	L=50	10050505
	L=60	10050605
	L=70	10050705
	L=80	10050805
	L=40	10060405
	L=45	10060455
	L=50	10060505
	L=60	10060605
	L=70	10060705
	L=80	10060805
	L=50	.18060505
	L=60	.18060605
	L=70	.18060705
	L=80	.18060805
	L=100	.18061005
	L=120	.18061205
	X CR	
	L=16	A0412
	L=25	A0412-5025
	L=70	A0412-5070
	L=100	A0412-50100