

MONOLITO KRIPTON

ROK SFERIK

PAT. PEND.



GRADO 4



PAG

MONOLITO KRIPTON



PAG



PAG



PAG



CARBIDE



OPTIONAL memory system

Mn CARBIDE



ANTISKETTING system

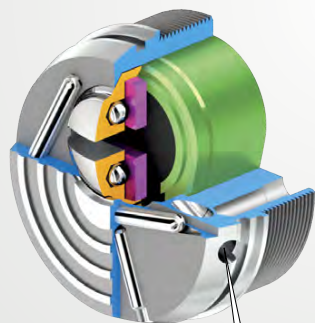

memory system
OPTIONAL

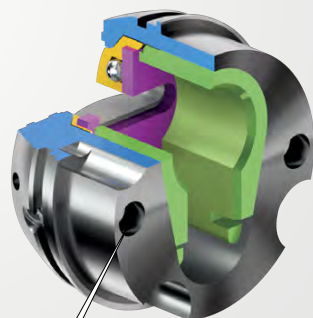

FLEX system

OPTIONAL
MEMORY SYSTEM

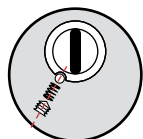
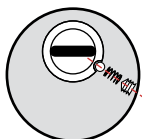

FLEX SYSTEM



5 VOLTE PIU' RESISTENTE DELLE VITI TRADIZIONALI 12.9

SUPER TOP
86x66

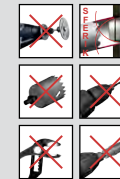

TOP
88x68



MONOLITO
88x68

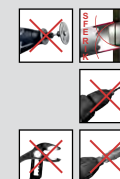

MILANO
Ø 65



MONOLITO E
Ø 65

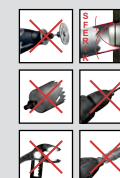

QUADRA
65x65

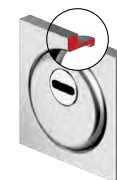

QUADRY
84x64

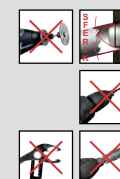



PAT. PEND.



	X ATRA		X ATRA	
H	MA3633	MA3634	MA3633..	MA3634..
20				
25	MA3627	MA3626	MA3627..	MA3626..
35				
35	MA3626	MA3625	MA3626..	MA3625..
45				
45	MA3628	MA3627	MA3628..	MA3627..

A2209.. H 20
A1561.. H 25/35/45

C	Cromo lucido	Bright Chrome
T	Cromo satinato	Satin Chrome
B	Bronzo	Bronze
2	PVD Ottone	PVD Brass
TT	Ottone satinato	Satin Brass
BS	Bronzo satinato	Satin Bronze
IT	Inox satinato	Stainless steel

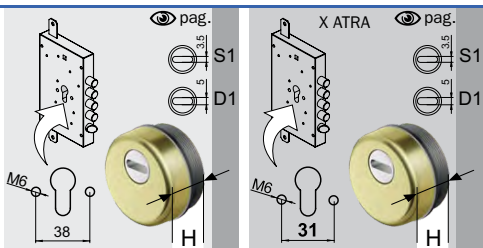

FINITURE FINISHES

C	Cromo lucido	Bright Chrome
T	Cromo satinato	Satin Chrome
B	Bronzo	Bronze
2	PVD Ottone	PVD Brass
TT	Ottone satinato	Satin Brass
BS	Bronzo satinato	Satin Bronze
IT	Inox satinato	Stainless steel

SUPER TOP 56x66			KT2896 h7 KT2897 h11
TOP 88x68			KT2002 h5 KT2001 h9
MONOLITO 88x68			A2082 h5 A1559 h11
MILANO Ø 65			A1612 h5 A1936 h11
MONOLITO E Ø 65			A2199
QUADRA 65x65			A3171 h5 A3060 h11
QUADRY 84x64			KT3481 h5 KT3482 h11

7 min			
5 min			
5 min			
5 min			
5 min			

BD291N 20	BD291N 25	BD291N 35	BD291N 45	BD290N 20	BD290N 25	BD290N 35	BD290N 45	BD391N 20	BD391N 25	BD391N 35	BD391N 45	BD390N 20	BD390N 25	BD390N 35	BD390N 45
BD271N 20	BD271N 25	BD271N 35	BD271N 45	BD270N 20	BD270N 25	BD270N 35	BD270N 45	BD371N 20	BD371N 25	BD371N 35	BD371N 45	BD370N 20	BD370N 25	BD370N 35	BD370N 45
BD251N 20	BD251N 25	BD251N 35	BD251N 45	BD250N 20	BD250N 25	BD250N 35	BD250N 45	BD351N 20	BD351N 25	BD351N 35	BD351N 45	BD350N 20	BD350N 25	BD350N 35	BD350N 45
BD261N 20	BD261N 25	BD261N 35	BD261N 45	BD260N 20	BD260N 25	BD260N 35	BD260N 45	BD361N 20	BD361N 25	BD361N 35	BD361N 45	BD360N 20	BD360N 25	BD360N 35	BD360N 45
BD28AN 20	BD28AN 25	BD28AN 35	BD28AN 45	BD251QN 20	BD251QN 25	BD251QN 35	BD251QN 45	BD250QN 20	BD250QN 25	BD250QN 35	BD250QN 45	BD351QN 20	BD351QN 25	BD351QN 35	BD351QN 45
BD251WN 20	BD251WN 25	BD251WN 35	BD251WN 45	BD250WN 20	BD250WN 25	BD250WN 35	BD250WN 45	BD351WN 20	BD351WN 25	BD351WN 35	BD351WN 45	BD350WN 20	BD350WN 25	BD350WN 35	BD350WN 45

ESEMPIO DI CODICE PER VITI M8



FINITURE FINISHES

C	Cromo lucido	Bright Chrome
T	Cromo satinato	Satin Chrome
B	Bronzo	Bronze
2	PVD Ottone	PVD Brass
BS	Bronzo satinato	Satin Bronze
IT	Inox satinato	Stainless steel

Ø50

PAT. PEND.

SFERIK

	X ATRA	X CR
H	MA3636 MA3635 MA2366	MA3636.. MA3635.. MA2366..
20	MA3636 MA3635 MA2366	MA3636.. MA3635.. MA2366..
25	MA3624 MA3623 MA2051	MA3624.. MA3623.. MA2051..
35	MA3630 MA3629 MA2055	MA3630.. MA3629.. MA2055..
45	MA3632 MA3631	MA3632.. MA3631..

A2209.. H 20
A1561.. H 25/35/45

- C Cromo lucido / Bright Chrome
- T Cromo satinato / Satin Chrome
- B Bronzo / Bronze
- 2 PVD Ottone / PVD Brass
- BS Bronzo satinato / Satin Bronze
- IT Inox satinato / Stainless steel

Model	Top	Bottom	Key
SUPER TOP 56x66			KT2896TK h7 KT2897TK h11
TOP 88x68			KT2002TK h5 KT2001TK h9
MONOLITO 88x68			A2815 h5 A2816 h11
MILANO Ø 65			A1612TK h5 A1936TK h11
MONOLITO E Ø 65			A2199TK
QUADRA 65x65			A3171TK h5 A3060TK h11
QUADRY 84x64			KT3481TK h5 KT3482TK h11

Model	Top	Bottom	Key
BDT291N			7 min / 11 min
BDT271N			5 min / 9 min
BD201N			5 min / 11 min
BDT211N			5 min / 11 min
BDT251Q			5 min / 11 min
BDT251W			5 min / 11 min

Model	Top	Bottom	Key
BDT291N	20 25 35 45	20 25 35 45	..
BDT290N	20 25 35 45	20 25 35 45	..
BDT271N	20 25 35 45	20 25 35 45	..
BDT270N	20 25 35 45	20 25 35 45	..
BD201N	20 25 35 45	20 25 35 45	..
BD200N	20 25 35 45	20 25 35 45	..
BDT211N	20 25 35 45	20 25 35 45	..
BDT210N	20 25 35 45	20 25 35 45	..
BDT28AN	20 25 35 45	20 25 35 45	..
BDT251QN	20 25 35 45	20 25 35 45	..
BDT250QN	20 25 35 45	20 25 35 45	..
BDT251WN	20 25 35 45	20 25 35 45	..
BDT250WN	20 25 35 45	20 25 35 45	..
BDT391N	20 25 35 45	20 25 35 45	..
BDT390N	20 25 35 45	20 25 35 45	..
BDT371N	20 25 35 45	20 25 35 45	..
BDT370N	20 25 35 45	20 25 35 45	..
BD301N	20 25 35 45	20 25 35 45	..
BD300N	20 25 35 45	20 25 35 45	..
BDT311N	20 25 35 45	20 25 35 45	..
BDT310N	20 25 35 45	20 25 35 45	..
BDT38AN	20 25 35 45	20 25 35 45	..
BDT351QN	20 25 35 45	20 25 35 45	..
BDT350QN	20 25 35 45	20 25 35 45	..
BDT351WN	20 25 35 45	20 25 35 45	..
BDT350WN	20 25 35 45	20 25 35 45	..

MONOLITO VERSIONE 2015

BD401 20
BD401 25
BD401 35
BD400 20
BD400 25
BD400 35

pag. S1 D1

pag. S1 D1

pag. S1 D1

pag. S1 D1

FINITURE FINISHES

- C Cromo lucido / Bright Chrome
- T Cromo satinato / Satin Chrome
- B Bronzo / Bronze
- 2 PVD Ottone / PVD Brass
- BS Bronzo satinato / Satin Bronze
- IT Inox satinato / Stainless steel

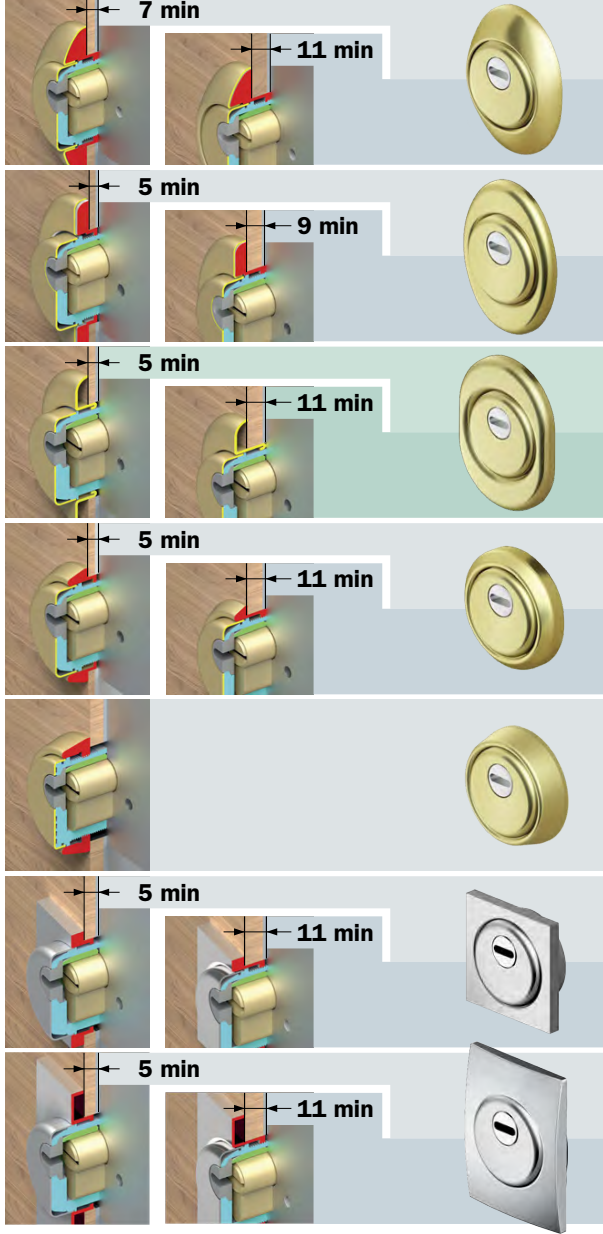
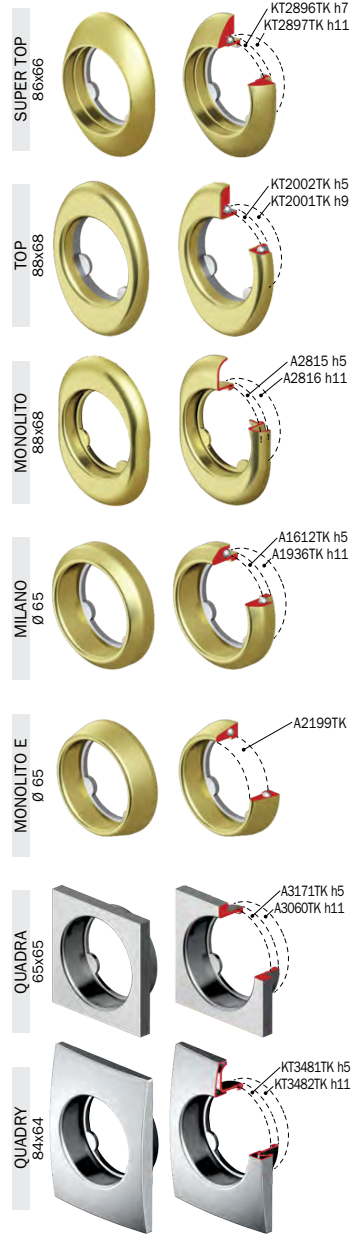
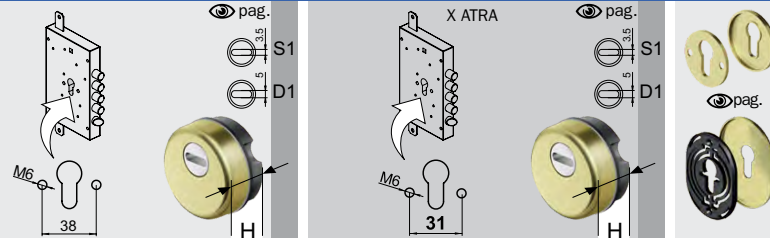
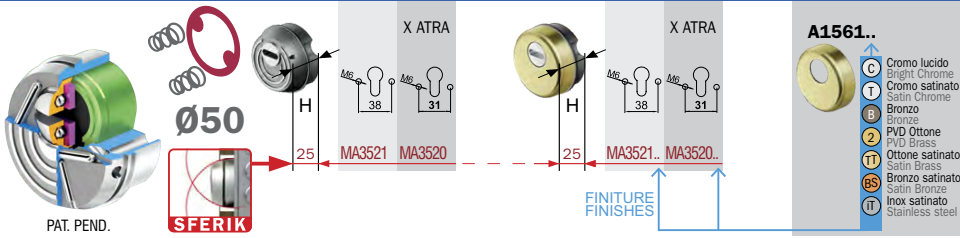

NNNN

NNNN

NNNN

NNNN

NNNN

NNNN

NNNN

BFT291	25	BFT391	25
BFT290	25	BFT390	25
BFT271	25	BFT371	25
BFT270	25	BFT370	25
BF201	25	BF301	25
BF200	25	BF300	25
BFT211	25	BFT311	25
BFT210	25	BFT310	25
BFT28A	25	BFT38A	25
BFT251Q	25	BFT351Q	25
BFT250Q	25	BFT350Q	25
BFT251W	25	BFT351W	25
BFT250W	25	BFT350W	25

- FINITURE FINISHES**
- C Cromo lucido / Bright Chrome
 - T Cromo satinato / Satin Chrome
 - B Bronzo / Bronze
 - 2 PVD Ottone / PVD Brass
 - 11 Ottone satinato / Satin Brass
 - BS Bronzo satinato / Satin Bronze
 - IT Inox satinato / Stainless steel

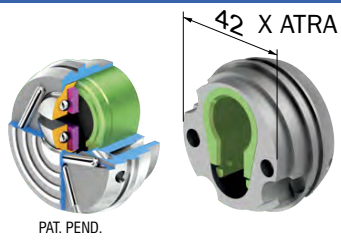

PAT. PEND.

42 X ATRA



Ø50

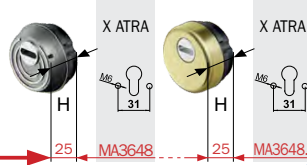

- A1561..**
- C Cromo lucido Bright Chrome
 - T Cromo satinato Satin Chrome
 - B Bronzo Bronze
 - 2 PVD Ottone PVD Brass
 - TT Ottone satinato Satin Brass
 - BS Bronzo satinato Satin Bronze
 - IT Inox satinato Stainless steel

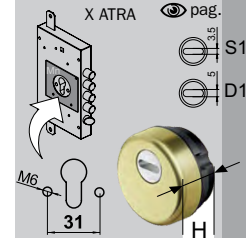
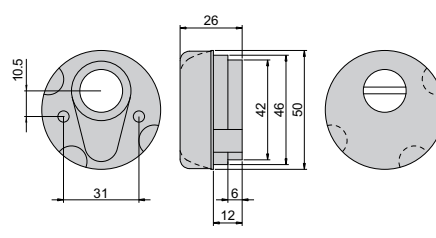

FINITURE FINISHES

- C Cromo lucido Bright Chrome
- T Cromo satinato Satin Chrome
- B Bronzo Bronze
- 2 PVD Ottone PVD Brass
- TT Ottone satinato Satin Brass
- BS Bronzo satinato Satin Bronze
- IT Inox satinato Stainless steel

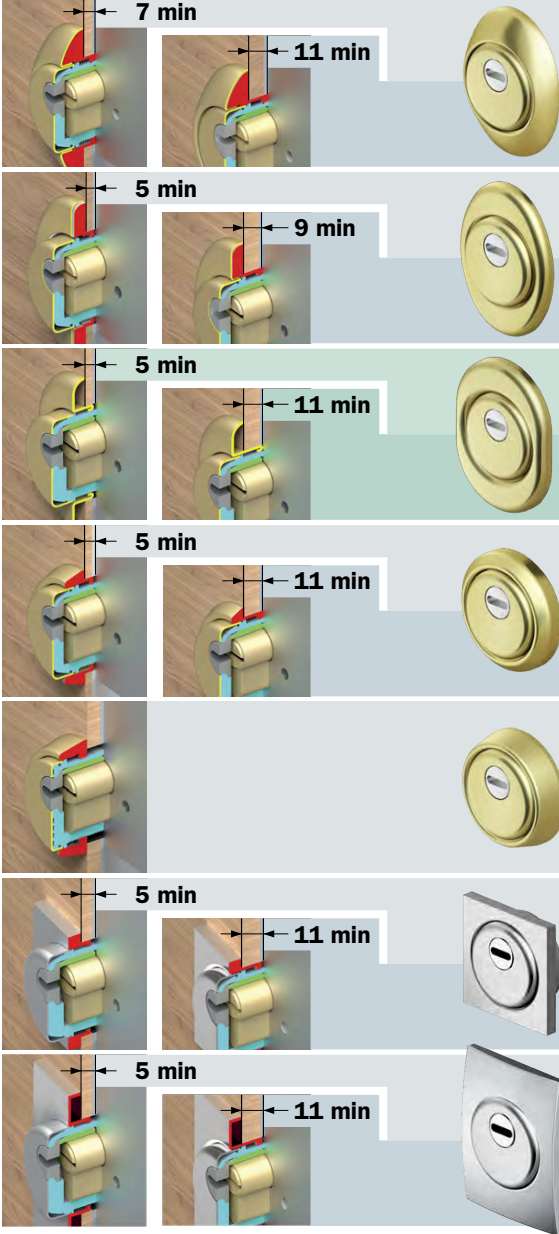
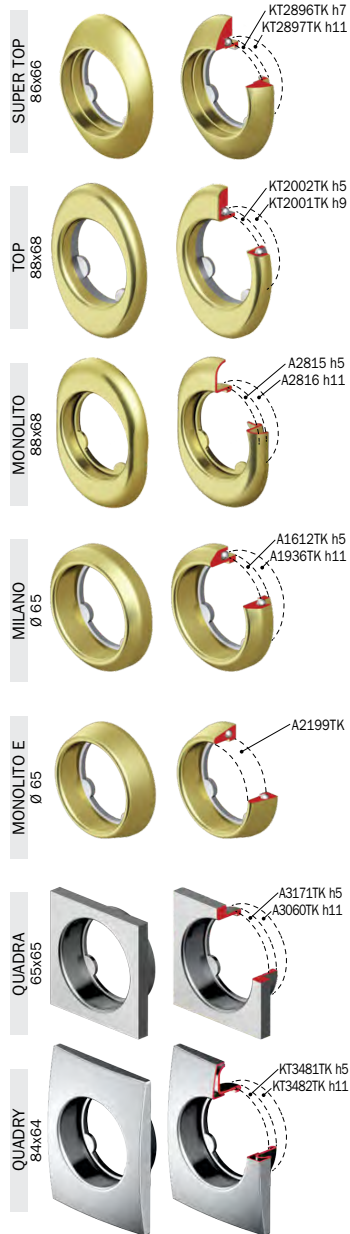

BD321ST	25
BD320ST	25
BD321T	25
BD320T	25
BD321N	25
BD320N	25
BD321M	25
BD320M	25
BD321E	25
BD321Q	25
BD320Q	25
BD321W	25
BD320W	25



- C Cromo lucido Bright Chrome
- T Cromo satinato Satin Chrome
- B Bronzo Bronze
- 2 PVD Ottone PVD Brass
- BS Bronzo satinato Satin Bronze
- IT Inox satinato Stainless steel

SUPER TOP

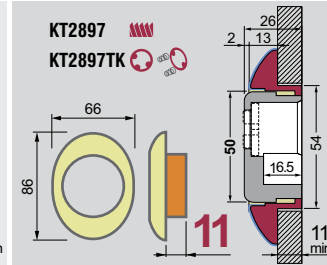
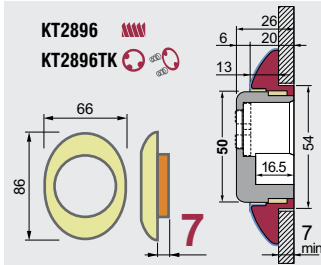

TOP

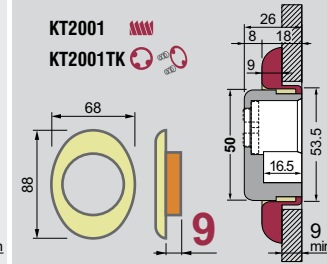
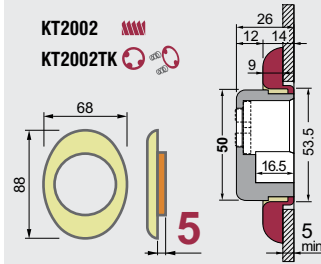

MONOLITO

OPTIONAL
A2073
SPESORE 5mm
SPACER 5mm
PAG

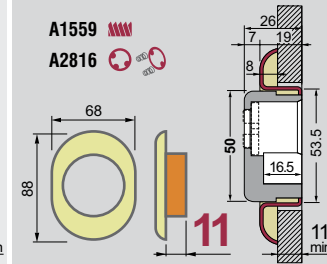
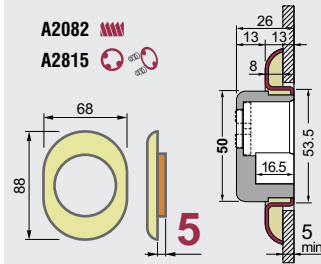

STONE

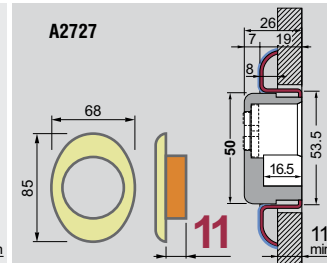
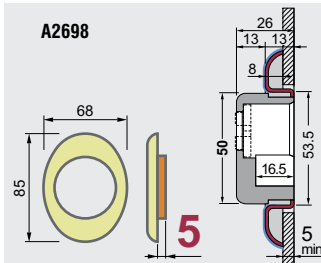

MILANO

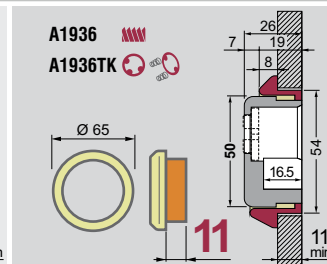
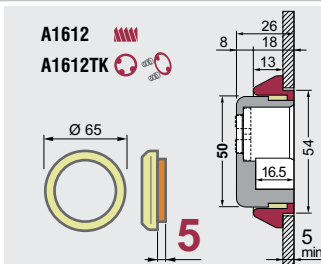

MONOLITO E

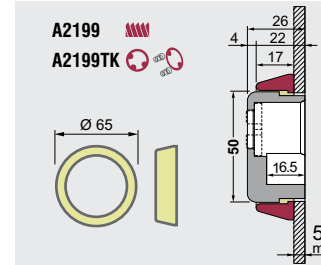

QUADRA

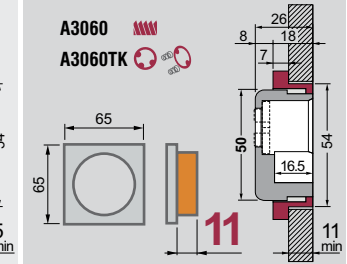
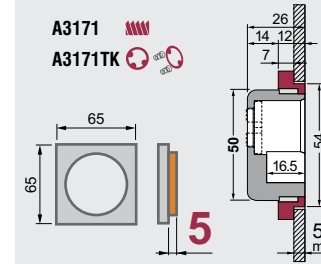

QUADRY

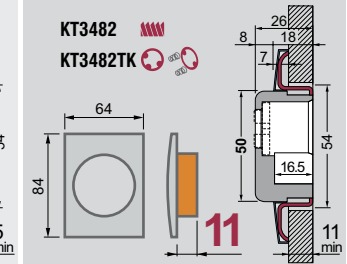
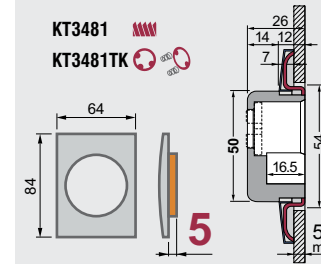

QUADRY P

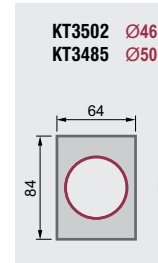

KUBO

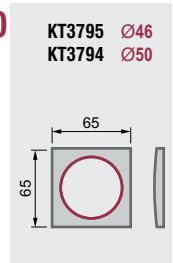

STANDARD

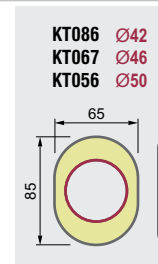

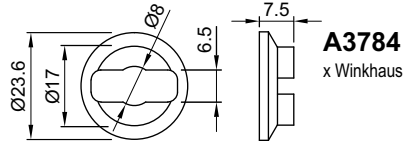
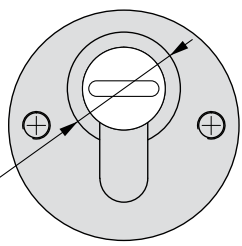

A3784
x Winkhaus

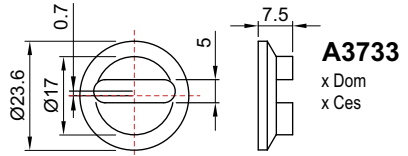

A3733
x Dom
x Ces

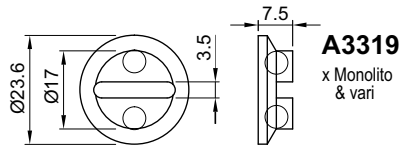

A3319
x Monolito
& vari

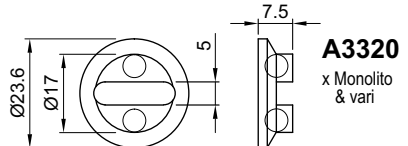

A3320
x Monolito
& vari

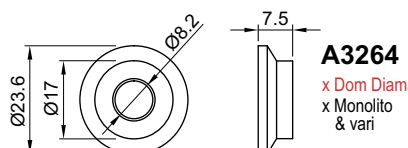

A3264
x Dom Diamant
x Monolito
& vari

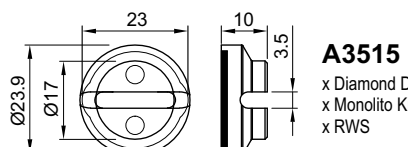

A3515
x Diamond Disec
x Monolito Krypton
x RWS

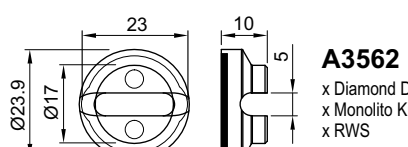

A3562
x Diamond Disec
x Monolito Krypton
x RWS

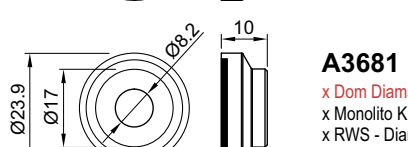

A3681
x Dom Diamant
x Monolito Krypton
x RWS - Diamond

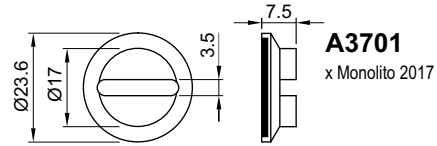

A3701
x Monolito 2017

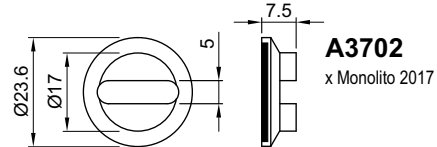

A3702
x Monolito 2017

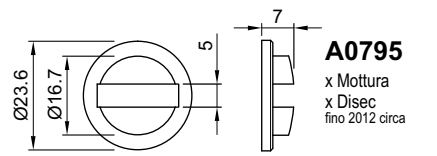

A0795
x Mottura
x Disec
fino 2012 circa

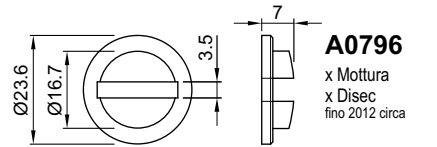

A0796
x Mottura
x Disec
fino 2012 circa

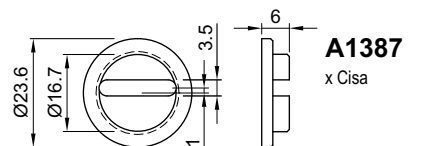

A1387
x Cisa

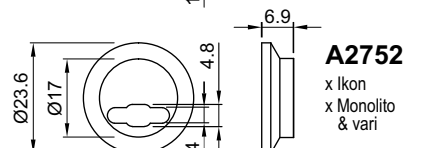

A2752
x Ikon
x Monolito
& vari

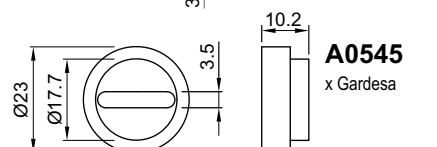

A0545
x Gardesa

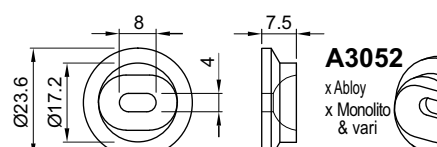

A3052
x Abloy
x Monolito
& vari

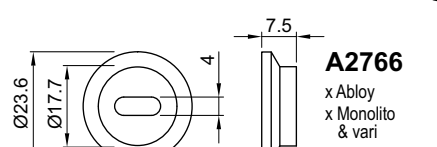

A2766
x Abloy
x Monolito
& vari

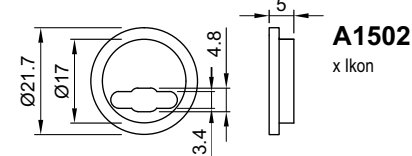
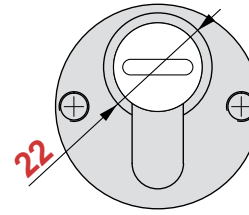

A1502
x Ikon

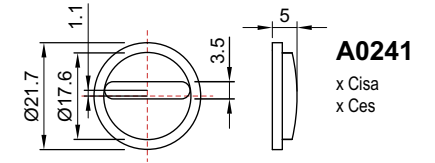

A0241
x Cisa
x Ces

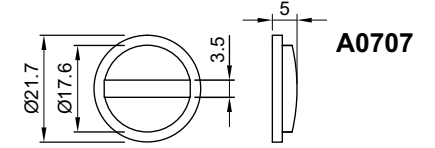

A0707

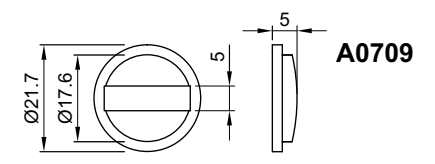

A0709

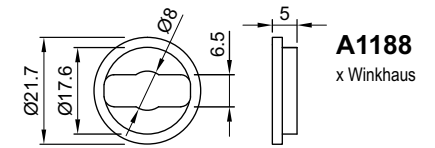

A1188
x Winkhaus

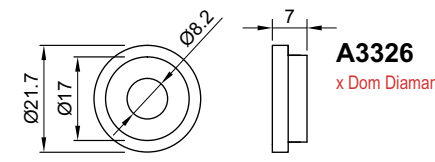

A3326
x Dom Diamant

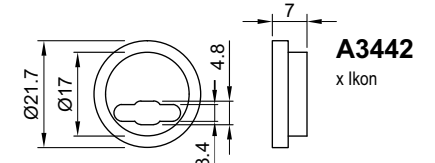

A3442
x Ikon

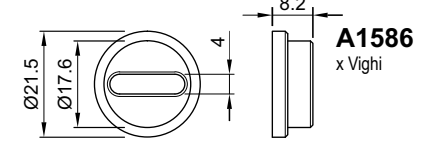

A1586
x Vighi

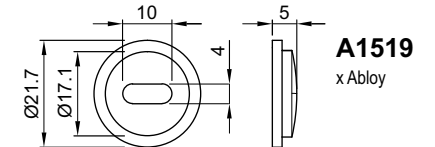

A1519
x Abloy



T

Cromo satinato
Satin chrome



iT

Inox satinato
Stainless steel



W

Bianco (RAL 9010)
White (RAL 9010)



6

Alluminio silver
Silver aluminium



C

Cromo lucido
Polished chrome



N

Nero
Black



9

Alluminio oro
Gold aluminium



L

Ottone lucido
Polished brass



M

Marrone
Brown



A

Alluminio champagne
Champagne aluminium

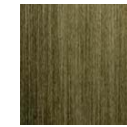

BS

Bronzo satinato
Satin bronze



2

PVD ottone
PVD bright brass



TT

Ottone satinato
Satin brass



B

Bronzo
Bronze

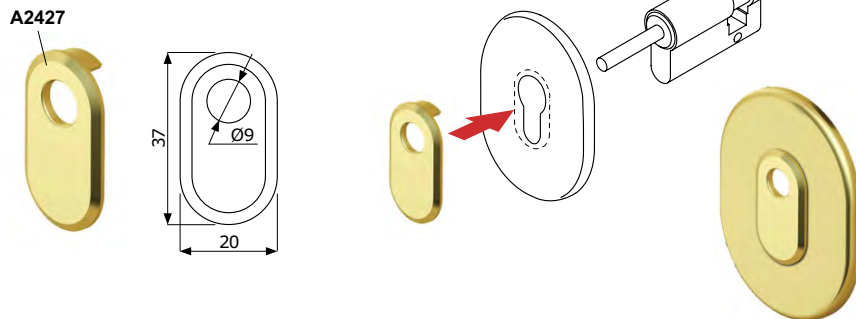
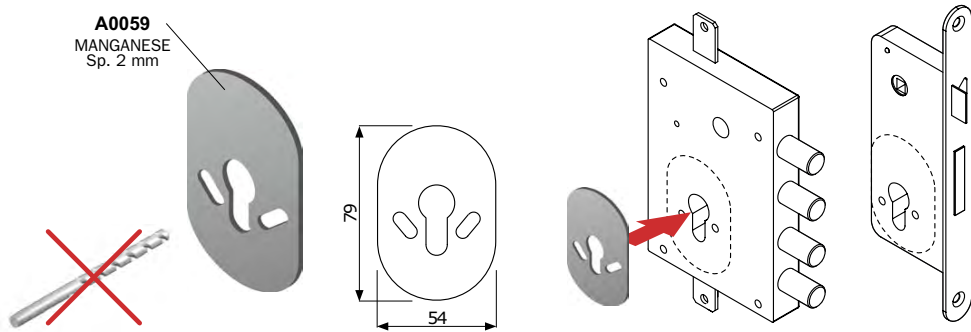
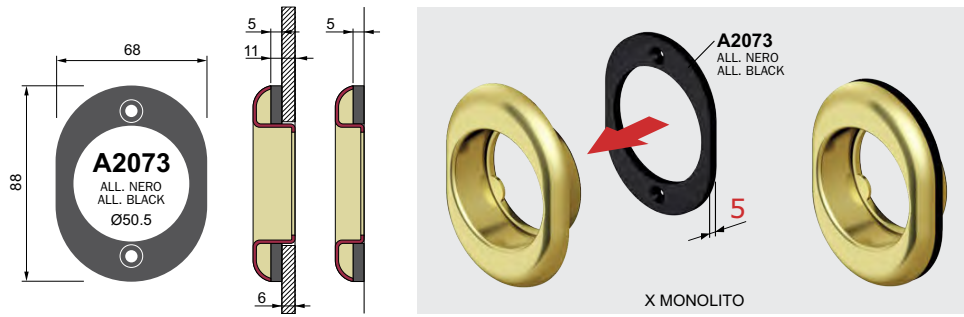

FINITURE / FINISHES

- C Cromo lucido / Bright Chrome
- B Bronzo / Bronze
- L Ottone lucido / Bright Brass
- T Cromo satinato / Satin Chrome
- N Nero / Black

Ø 50	UNIVERSAL			
	A1565 1mm			
	A1566 2mm			
	A2755 5mm			
	A2756 10mm			
	A2763 15mm			
Ø 45	A2578 2mm			
	A3375 2mm			
Ø 44	X FIAM			
	A0592 1mm			
Ø 42	A0591 2mm			
	A2633 2mm			
Ø 40	A3185 5mm			
	X ESETY X ATRA X CR			
	A1063 1mm			
	A1056 2mm			

	L=43	10060435
	L=40	10080405
	L=40	10040405
	L=45	10040455
	L=50	10040505
	L=60	10040605
	L=70	10040705
	L=80	10040805
	L=40	10050405
	L=45	10050455
	L=50	10050505
	L=60	10050605
	L=70	10050705
	L=80	10050805
	L=40	10060405
	L=45	10060455
	L=50	10060505
	L=60	10060605
	L=70	10060705
	L=80	10060805
	L=50	.18060505
	L=60	.18060605
	L=70	.18060705
	L=80	.18060805
	L=100	.18061005
	L=120	.18061205
	X CR	
	L=16	A0412
	L=25	A0412-5025
	L=70	A0412-5070
	L=100	A0412-50100



SERVICE KIT
430x290x55 mm
ACCIAIO INOX SATINATO



SERVICE KIT mini
328x258x52 mm

18061205 20 pz Vite M6x120 testa svasata piana con cava esagonale CLASSE 10.9	18060705 20 pz Vite M6x70 testa svasata piana con cava esagonale CLASSE 10.9	10060405 10 pz Vite M6x40 testa cilindrica con cava esagonale CLASSE 12.9	28030052 20 pz Grano M3x5 con cava esagonale	25060065 20 pz Grano M6x6 con cava esagonale	25060405 20 pz Grano M6x40 con cava esagonale
18061005 20 pz Vite M6x100 testa svasata piana con cava esagonale CLASSE 10.9	18060605 20 pz Vite M6x60 testa svasata piana con cava esagonale CLASSE 10.9	10050405 10 pz Vite M5x40 testa cilindrica con cava esagonale CLASSE 8.8	31030125 100 pz Vite autofilettante Ø 3x12 testa svasata piana a croce BRONZO	31030125 100 pz Vite autofilettante Ø 3x12 testa svasata piana a croce ORO	
10061205 20 pz Vite M6x120 testa cilindrica con cava esagonale CLASSE 12.9	10060705 20 pz Vite M6x70 testa cilindrica con cava esagonale CLASSE 12.9	10080405 10 pz Vite M8x40 testa cilindrica con cava esagonale	31030125 100 pz Vite autofilettante Ø 3x12 testa svasata piana a croce ZINCATA	31040165 100 pz Vite autofilettante Ø 4x16 testa svasata piana a croce ORO	
10061005 20 pz Vite M6x100 testa cilindrica con cava esagonale CLASSE 12.9	10060605 20 pz Vite M6x60 testa cilindrica con cava esagonale CLASSE 12.9	13060200 10 pz Vite M6x20 testa tonda quadro sotto testa	30 pz Dadi esagonali M6	30 pz Rondella x M6	20 pz Sfera Ø 4,8 acciaio 10 pz Pin blocco SG A0716
10060805 20 pz Vite M6x80 testa cilindrica con cava esagonale CLASSE 12.9	10060505 20 pz Vite M6x50 testa cilindrica con cava esagonale CLASSE 12.9	A1566 10 pz Ø 50x2,5 Spessore universale	A2427N 12 pz Adattatore codolo (Nero)	A1056 10 pz Ø 40x2,5 Spessore universale	

18061205 10 pz Vite M6x120 CLASSE 10.9	10060805 10 pz Vite M6x80 CLASSE 12.9				
10061205 10 pz Vite M6x120 CLASSE 12.9	10061005 10 pz Vite M6x100 CLASSE 12.9				
A2578 10 pz Spessore m 8 Ø 50x2,5	18061005 10 pz Vite M6x100 CLASSE 10.9	10060705 10 pz Vite M6x70 CLASSE 12.9	10060605 10 pz Vite M6x60 CLASSE 12.9	10060505 10 pz Vite M6x50 CLASSE 12.9	
10 pz O-Ring Ø 41x1,78	A1566 10 pz Spessore universale Ø 50x2,5	10080405 10 pz Vite M8x40	31030125 4 pz Vite Ø 3x12 ORO	31030125 4 pz Vite Ø 3x12 BRONZO	31030125 4 pz Vite Ø 3x12 ZINCATA