



ROK SFERIK

PAT. PEND.



GRADO 4



PAG



PAG



VIDEO

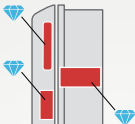

DIAMOND



DIAMOND CARBIDE



DIAMOND CARBIDE



DIAMOND

OPTIONAL
MEMORY SYSTEM

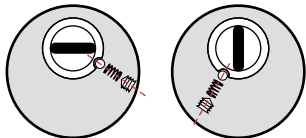

FLEX SYSTEM



5 VOLTE PIU' RESISTENTE DELLE VITI TRADIZIONALI 12.9

SUPER TOP
86x66



TOP
88x68



MONOLITO
88x68

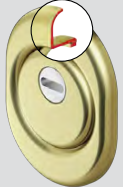

MILANO
Ø 65



MONOLITO E
Ø 65



QUADRA
65x65



QUADRY
84x64



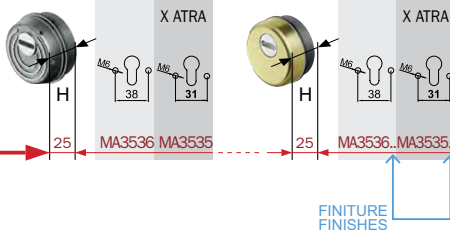

- A1561..**
- 0 Cromo lucido / Bright Chrome
 - 1 Cromo satinato / Satin Chrome
 - 3 Bronzo / Bronze
 - 2 PVD Ottone / PVD Brass
 - 4 Ottone satinato / Satin Brass
 - 5 Bronzo satinato / Satin Bronze
 - 8 Inox satinato / Stainless steel

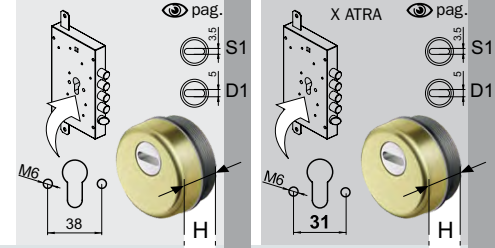

- FINITURE FINISHES**
- C Cromo lucido / Bright Chrome
 - T Cromo satinato / Satin Chrome
 - B Bronzo / Bronze
 - 2 PVD Ottone / PVD Brass
 - 4 Ottone satinato / Satin Brass
 - 5 Bronzo satinato / Satin Bronze
 - 8 Inox satinato / Stainless steel

SUPER TOP 56x66

TOP 88x68

MONOLITO 88x68

MILANO Ø 65

MONOLITO E Ø 65

QUADRA 65x65

QUADRY 84x64

7 min

11 min

5 min

9 min

5 min

11 min

5 min

11 min

5 min

11 min

5 min

11 min

5 min

11 min

BKD291	25	..	BKD391	25	..	BKD291 8 25..
BKD290	25	..	BKD390	25
BKD271	25	..	BKD371	25
BKD270	25	..	BKD370	25
BKD251	25	..	BKD351	25
BKD250	25	..	BKD350	25
BKD261	25	..	BKD361	25
BKD260	25	..	BKD360	25
BKD28A	25	..	BKD38A	25
BKD251Q	25	..	BKD351Q	25
BKD250Q	25	..	BKD350Q	25
BKD251W	25	..	BKD351W	25
BKD250W	25	..	BKD350W	25

ESEMPIO DI CODICE PER VITI M8

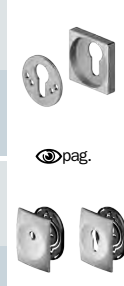

- FINITURE FINISHES**
- C Cromo lucido / Bright Chrome
 - T Cromo satinato / Satin Chrome
 - B Bronzo / Bronze
 - 2 PVD Ottone / PVD Brass
 - 5 Bronzo satinato / Satin Bronze
 - 8 Inox satinato / Stainless steel

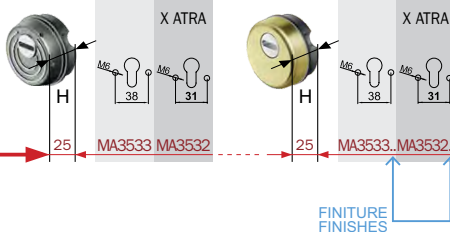

- A1561..**
- C Cromo lucido / Bright Chrome
 - T Cromo satinato / Satin Chrome
 - B Bronzo / Bronze
 - 2 PVD Ottonne / PVD Brass
 - TT Ottonne satinato / Satin Brass
 - BS Bronzo satinato / Satin Bronze
 - IT Inox satinato / Stainless steel

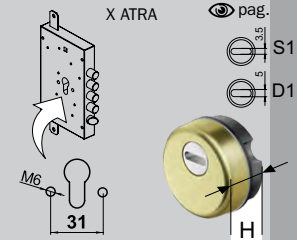
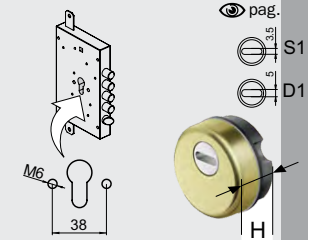

SUPER TOP
56x66

TOP
88x68

MONOLITO
88x68

MILANO
Ø 65

MONOLITO E
Ø 65

QUADRA
65x65

QUADRY
84x64

7 min

11 min

5 min

9 min

5 min

11 min

5 min

11 min

5 min

11 min

5 min

11 min

BKT291D	25	..	BKT391D	25
BKT290D	25	..	BKT390D	25
BKT271D	25	..	BKT371D	25
BKT270D	25	..	BKT370D	25
BKT201D	25	..	BKT301D	25
BKT200D	25	..	BKT300D	25
BKT211D	25	..	BKT311D	25
BKT210D	25	..	BKT310D	25
BKT28AD	25	..	BKT38AD	25
BKT251QD	25	..	BKT351QD	25
BKT250QD	25	..	BKT350QD	25
BKT251WD	25	..	BKT351WD	25
BKT250WD	25	..	BKT350WD	25

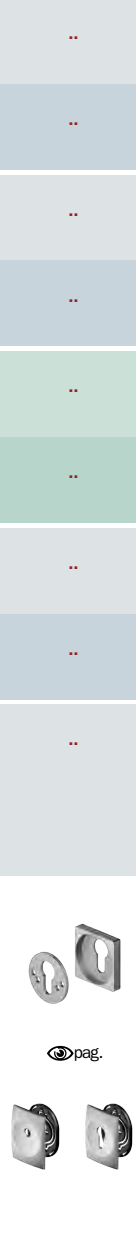

- FINITURE FINISHES**
- C Cromo lucido / Bright Chrome
 - T Cromo satinato / Satin Chrome
 - B Bronzo / Bronze
 - 2 PVD Ottonne / PVD Brass
 - TT Ottonne satinato / Satin Brass
 - BS Bronzo satinato / Satin Bronze
 - IT Inox satinato / Stainless steel

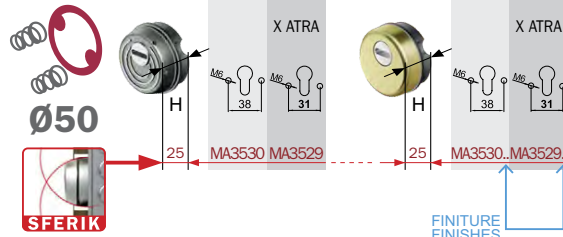

- A1561..**
- C Cromo lucido Bright Chrome
 - T Cromo satinato Satin Chrome
 - B Bronzo Bronze
 - 2 PVD Ottone PVD Brass
 - TT Ottone satinato Satin Brass
 - BS Bronzo satinato Satin Bronze
 - IT Inox satinato Stainless steel

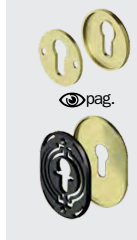
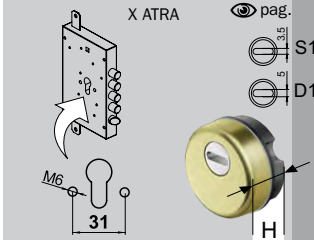
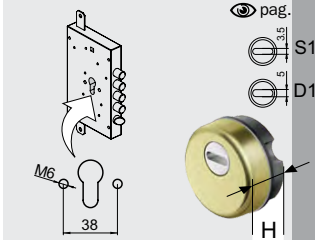

- FINITURE FINISHES**
- C Cromo lucido Bright Chrome
 - T Cromo satinato Satin Chrome
 - B Bronzo Bronze
 - 2 PVD Ottone PVD Brass
 - TT Ottone satinato Satin Brass
 - BS Bronzo satinato Satin Bronze
 - IT Inox satinato Stainless steel

SUPER TOP 56x66			KT2896TK h7 KT2897TK h11
TOP 88x68			KT2002TK h5 KT2001TK h9
MONOLITO 88x68			A2815 h5 A2816 h11
MILANO Ø 65			A1612TK h5 A1936TK h11
MONOLITO E Ø 65			A2199TK
QUADRA 65x65			A3171TK h5 A3060TK h11
QUADRY 84x64			KT3481TK h5 KT3482TK h11

		7 min		
		11 min		
		5 min		
		9 min		
		5 min		
		11 min		
		5 min		
		11 min		
		5 min		
		11 min		
		5 min		
		11 min		
		5 min		
		11 min		

BKF291D	25	..		BKF391D	25
BKF290D	25	..		BKF390D	25
BKF271D	25	..		BKF371D	25
BKF270D	25	..		BKF370D	25
BKF201D	25	..		BKF301D	25
BKF200D	25	..		BKF300D	25
BKF211D	25	..		BKF311D	25
BKF210D	25	..		BKF310D	25
BKF28AD	25	..		BKF38AD	25
BKF251QD	25	..		BKF351QD	25	..	
BKF250QD	25	..		BKF350QD	25	..	
BKF251WD	25	..		BKF351WD	25	..	
BKF250WD	25	..		BKF350WD	25	..	

- FINITURE FINISHES**
- C Cromo lucido Bright Chrome
 - T Cromo satinato Satin Chrome
 - B Bronzo Bronze
 - 2 PVD Ottone PVD Brass
 - BS Bronzo satinato Satin Bronze
 - IT Inox satinato Stainless steel

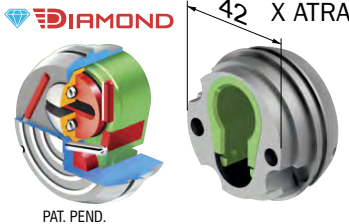

PAT. PEND.

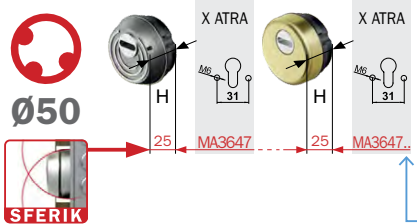

SFERIK

- A1561..**
- 1 Cromo lucido Bright Chrome
 - 2 Cromo satinato Satin Chrome
 - 3 Bronzo Bronze
 - 4 PVD Ottone PVD Brass
 - 5 Ottone satinato Satin Brass
 - 6 Bronzo satinato Satin Bronze
 - 7 Inox satinato Stainless steel

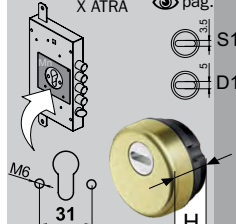
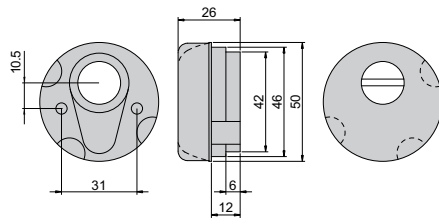

- FINITURE FINISHES**
- C Cromo lucido Bright Chrome
 - T Cromo satinato Satin Chrome
 - B Bronzo Bronze
 - 2 PVD Ottone PVD Brass
 - 5 Ottone satinato Satin Brass
 - 6 Bronzo satinato Satin Bronze
 - 7 Inox satinato Stainless steel

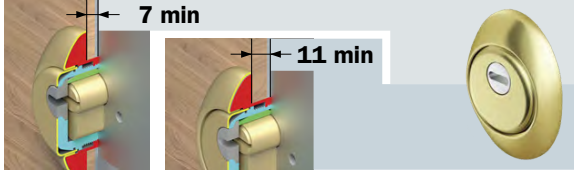

BK321ST 25

BK320ST 25

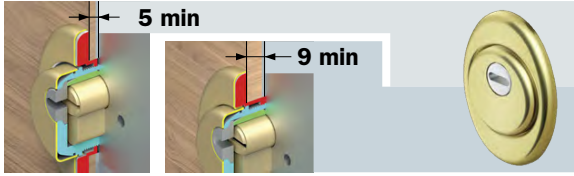
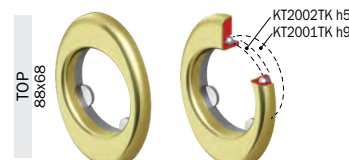

BK321T 25

BK320T 25

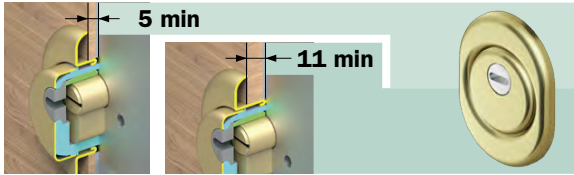
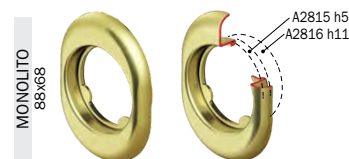

BK321 25

BK320 25



BK321M 25

BK320M 25

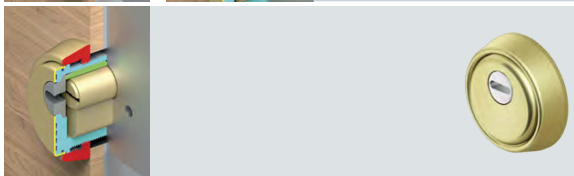
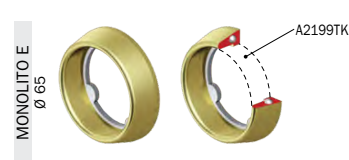

BK321E 25

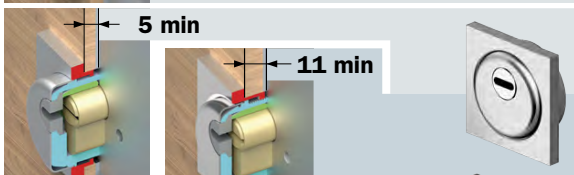
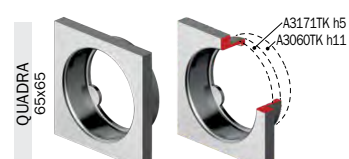

BK321Q 25

BK320Q 25

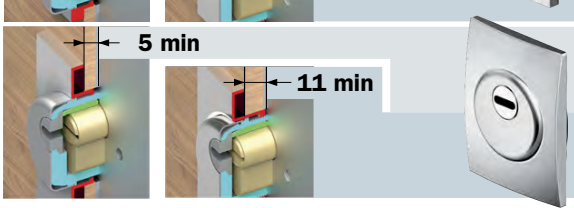
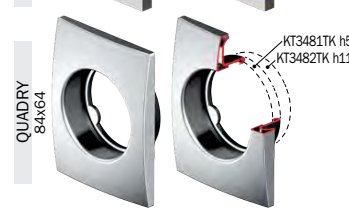

BK321W 25

BK320W 25



- FINITURE FINISHES**
- C Cromo lucido Bright Chrome
 - T Cromo satinato Satin Chrome
 - B Bronzo Bronze
 - 2 PVD Ottone PVD Brass
 - 5 Bronzo satinato Satin Bronze
 - 7 Inox satinato Stainless steel



DIAMOND



PAT. PEND.

Ø50

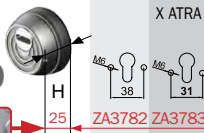

25 ZA3782 ZA3783

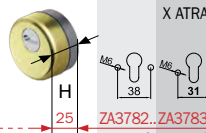

25 ZA3782..ZA3783..

FINITURE FINISHES

A0397..

- C Cromo lucido / Bright Chrome
- T Cromo satinato / Satin Chrome
- B Bronzo / Bronze
- Z PVD Ottone / PVD Brass
- TT Ottone satinato / Satin Brass
- BS Bronzo satinato / Satin Bronze
- IT Inox satinato / Stainless steel

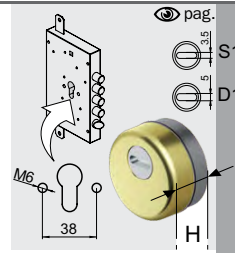

RKD16 25 .. P

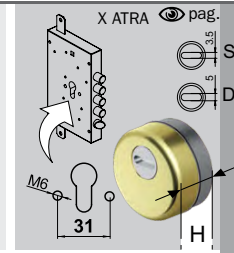

RKD68 25 .. P



RKD16 8 25..
ESEMPIO CODICE
EXAMPLE CODE



- C Cromo lucido / Bright Chrome
- T Cromo satinato / Satin Chrome
- B Bronzo / Bronze
- Z PVD Ottone / PVD Brass
- TT Ottone satinato / Satin Brass
- BS Bronzo satinato / Satin Bronze
- IT Inox satinato / Stainless Steel



DIAMOND



PAT. PEND.

Ø50

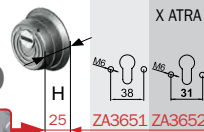

25 ZA3651 ZA3652

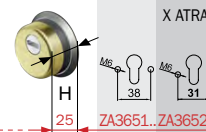

25 ZA3651..ZA3652..

FINITURE FINISHES

A0397..

- C Cromo lucido / Bright Chrome
- T Cromo satinato / Satin Chrome
- B Bronzo / Bronze
- Z PVD Ottone / PVD Brass
- TT Ottone satinato / Satin Brass
- BS Bronzo satinato / Satin Bronze
- IT Inox satinato / Stainless steel

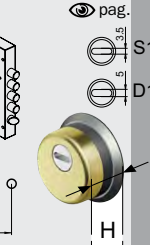
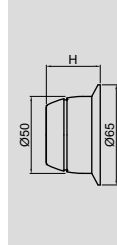

RKD42 25 .. P

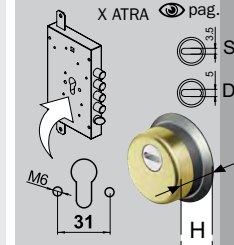

RKD48 25 .. P



RKD42 8 25..
ESEMPIO CODICE
EXAMPLE CODE

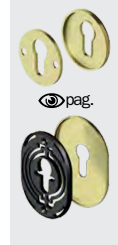

- C Cromo lucido / Bright Chrome
- T Cromo satinato / Satin Chrome
- B Bronzo / Bronze
- Z PVD Ottone / PVD Brass
- TT Ottone satinato / Satin Brass
- BS Bronzo satinato / Satin Bronze
- IT Inox satinato / Stainless Steel



SUPER TOP

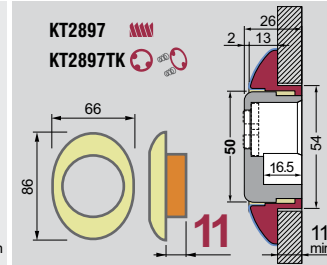
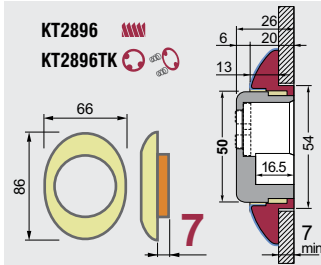

TOP

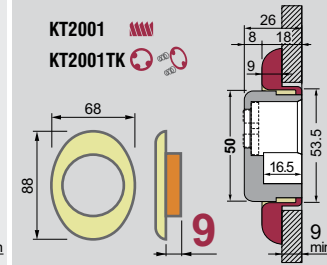
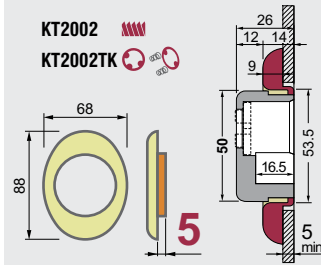

MONOLITO

OPTIONAL
A2073
SPESORE 5mm
SPACER 5mm
PAG

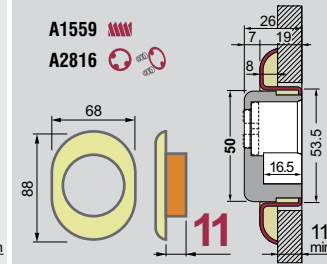
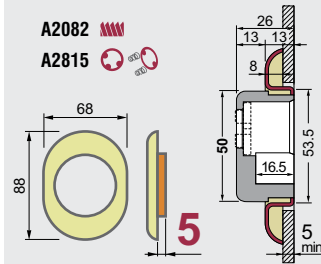

STONE

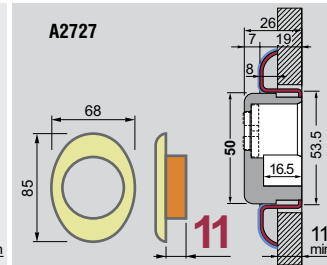
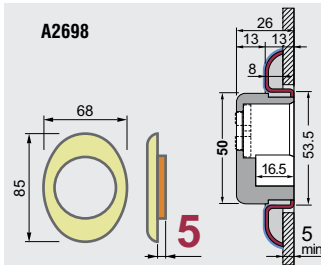

MILANO

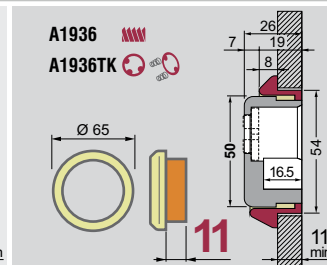
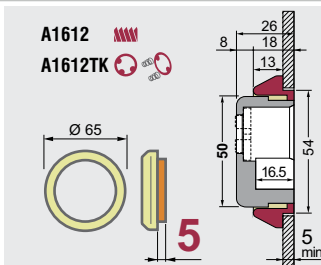

MONOLITO E

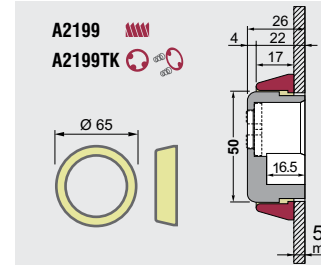

QUADRA

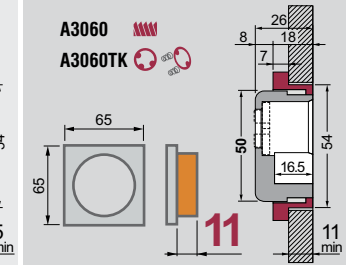
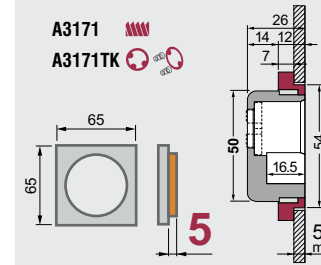

QUADRY

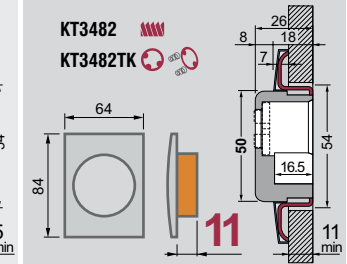
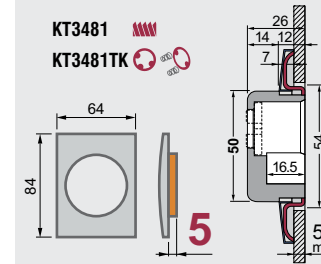

QUADRY P

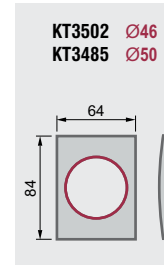

KUBO

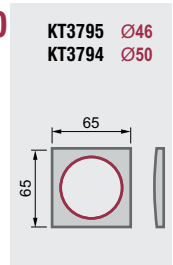

STANDARD

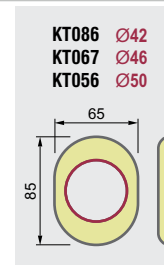

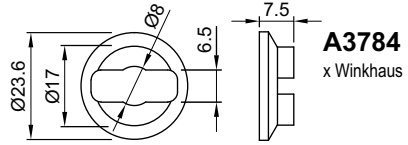
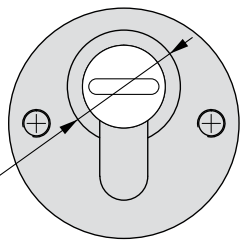

A3784
x Winkhaus

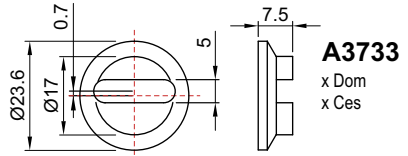

A3733
x Dom
x Ces

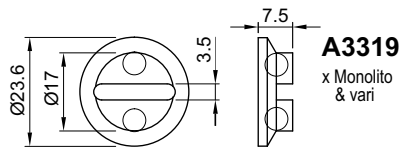

A3319
x Monolito
& vari

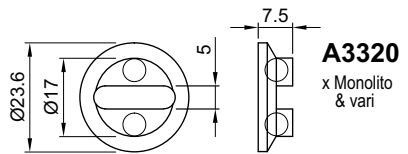

A3320
x Monolito
& vari

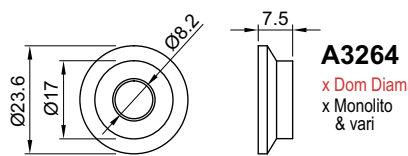

A3264
x Dom Diamant
x Monolito
& vari

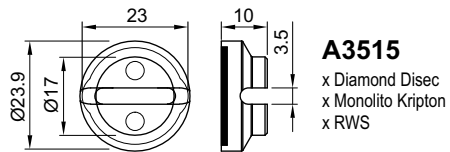

A3515
x Diamond Disec
x Monolito Krypton
x RWS

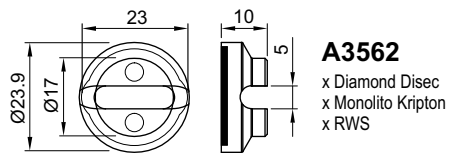

A3562
x Diamond Disec
x Monolito Krypton
x RWS

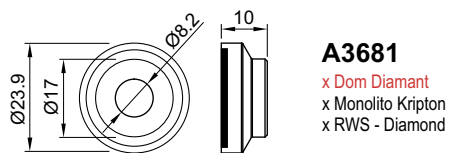

A3681
x Dom Diamant
x Monolito Krypton
x RWS - Diamond

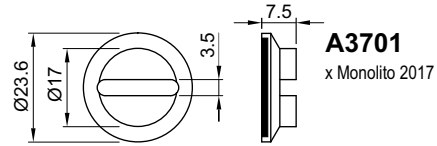

A3701
x Monolito 2017

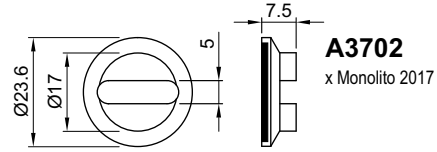

A3702
x Monolito 2017

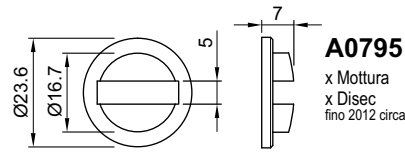

A0795
x Mottura
x Disec
fino 2012 circa

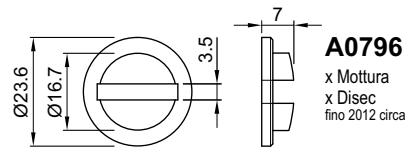

A0796
x Mottura
x Disec
fino 2012 circa

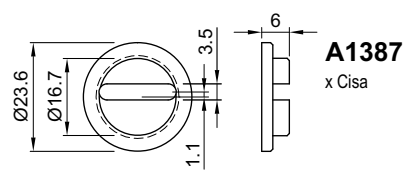

A1387
x Cisa

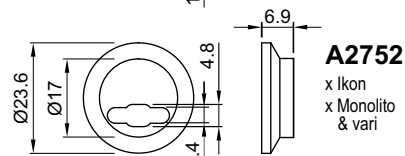

A2752
x Ikon
x Monolito
& vari

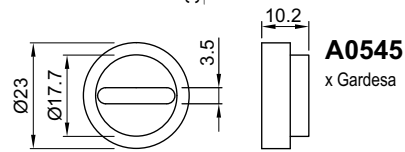

A0545
x Gardesa

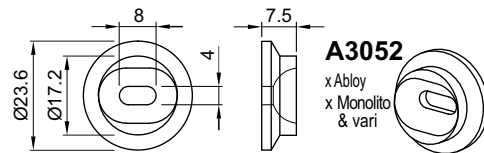

A3052
x Abloy
x Monolito
& vari

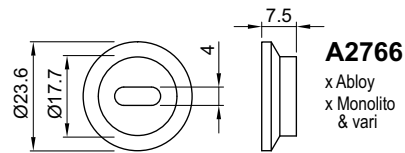

A2766
x Abloy
x Monolito
& vari

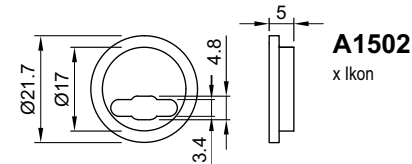
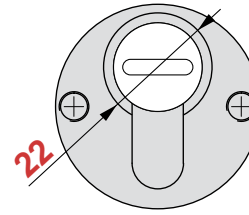

A1502
x Ikon

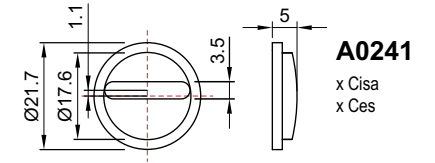

A0241
x Cisa
x Ces

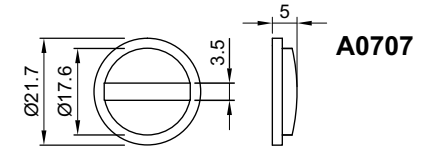

A0707

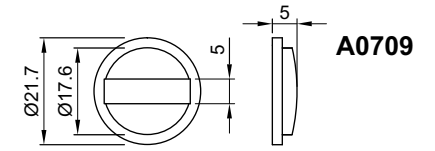

A0709

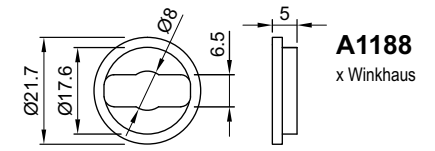

A1188
x Winkhaus

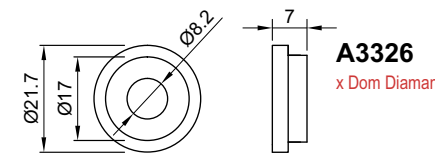

A3326
x Dom Diamant

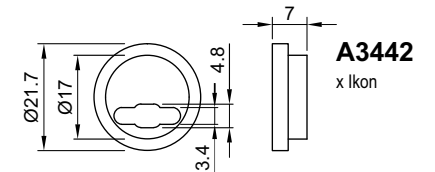

A3442
x Ikon

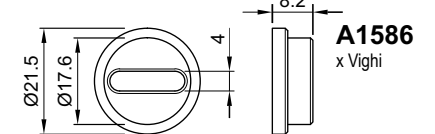

A1586
x Vighi

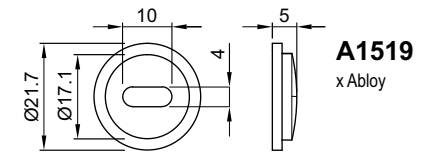

A1519
x Abloy



T

Cromo satinato
Satin chrome



iT

Inox satinato
Stainless steel



W

Bianco (RAL 9010)
White (RAL 9010)

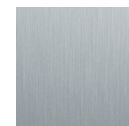

6

Alluminio silver
Silver aluminium



C

Cromo lucido
Polished chrome

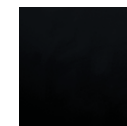

N

Nero
Black



9

Alluminio oro
Gold aluminium



L

Ottone lucido
Polished brass

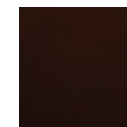

M

Marrone
Brown



A

Alluminio champagne
Champagne aluminium



BS

Bronzo satinato
Satin bronze



2

PVD ottone
PVD bright brass



TT

Ottone satinato
Satin brass



B



























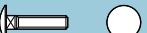

Bronzo
Bronze











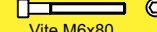
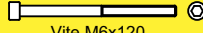
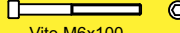

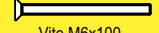

SERVICE KIT
430x290x55 mm
ACCIAIO INOX SATINATO



SERVICE KIT mini
328x258x52 mm

18061205 20 pz  Vite M6x120 testa svasata piana con cava esagonale CLASSE 10.9	18060705 20 pz  Vite M6x70 testa svasata piana con cava esagonale CLASSE 10.9	10060405 10 pz  Vite M6x40 testa cilindrica con cava esagonale CLASSE 12.9	28030052 20 pz  Grano M3x5 con cava esagonale	25060065 20 pz  Grano M6x6 con cava esagonale	25060405 20 pz  Grano M6x40 con cava esagonale
18061005 20 pz  Vite M6x100 testa svasata piana con cava esagonale CLASSE 10.9	18060605 20 pz  Vite M6x60 testa svasata piana con cava esagonale CLASSE 10.9	10050405 10 pz  Vite M5x40 testa cilindrica con cava esagonale CLASSE 8.8	31030125 100 pz  Vite autofilettante Ø 3x12 testa svasata piana a croce BRONZO	31030125 100 pz  Vite autofilettante Ø 3x12 testa svasata piana a croce ORO	
10061205 20 pz  Vite M6x120 testa cilindrica con cava esagonale CLASSE 12.9	10060705 20 pz  Vite M6x70 testa cilindrica con cava esagonale CLASSE 12.9	10080405 10 pz  Vite M8x40 testa cilindrica con cava esagonale	31030125 100 pz  Vite autofilettante Ø 3x12 testa svasata piana a croce ZINCATA	31040165 100 pz  Vite autofilettante Ø 4x16 testa svasata piana a croce ORO	
10061005 20 pz  Vite M6x100 testa cilindrica con cava esagonale CLASSE 12.9	10060605 20 pz  Vite M6x60 testa cilindrica con cava esagonale CLASSE 12.9	13060200 10 pz  Vite M6x20 testa tonda quadro sotto testa	30 pz  Dadi esagonali M6	30 pz  Rondella x M6	20 pz  Sfera Ø 4,8 acciaio 10 pz  A0716 Pin blocco SG 10 pz  O-Ring Ø 41x1,78
10060805 20 pz  Vite M6x80 testa cilindrica con cava esagonale CLASSE 12.9	10060505 20 pz  Vite M6x50 testa cilindrica con cava esagonale CLASSE 12.9	A1566 10 pz  Ø 50x2,5 Spessore universale	A2427N 12 pz  Adattatore codolo (Nero)	A1056 10 pz  Ø 40x2,5 Spessore universale	

18061205 10 pz  Vite M6x120 CLASSE 10.9	10060805 10 pz  Vite M6x80 CLASSE 12.9				
10061205 10 pz  Vite M6x120 CLASSE 12.9	10061005 10 pz  Vite M6x100 CLASSE 12.9				
A2578 10 pz  Spessore m 8 Ø 50x2,5	18061005 10 pz  Vite M6x100 CLASSE 10.9	10060705 10 pz  Vite M6x70 CLASSE 12.9	10060605 10 pz  Vite M6x60 CLASSE 12.9	10060505 10 pz  Vite M6x50 CLASSE 12.9	
10 pz  O-Ring Ø 41x1,78	A1566 10 pz  Spessore universale Ø 50x2,5	10080405 10 pz  Vite M8x40	31030125 4 pz  Vite Ø 3x12 ORO	31030125 4 pz  Vite Ø 3x12 BRONZO	31030125 4 pz  Vite Ø 3x12 ZINCATA

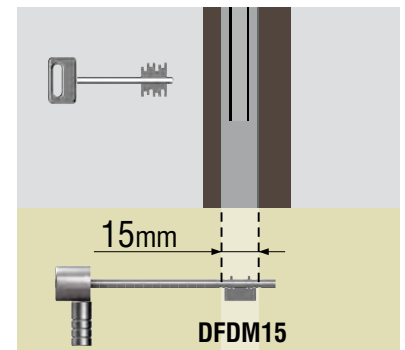
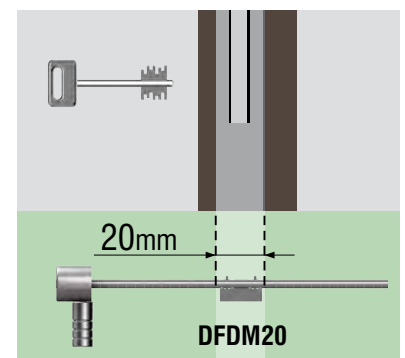
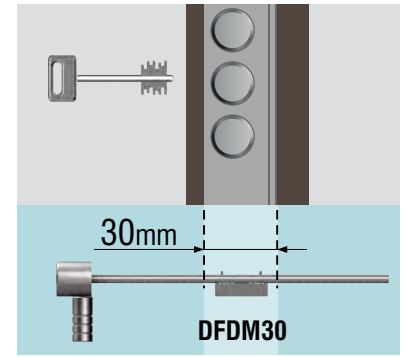
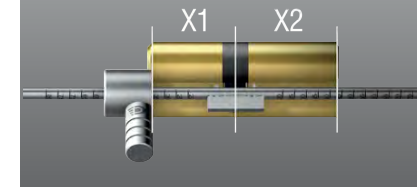
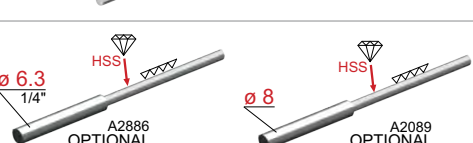
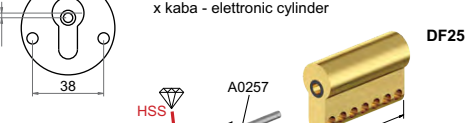
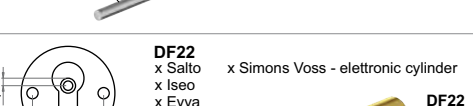
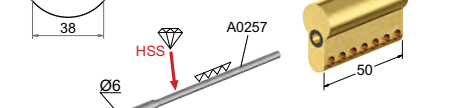
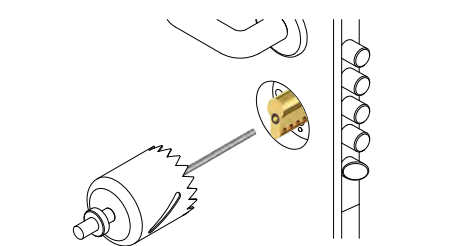
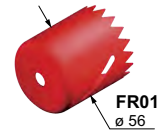
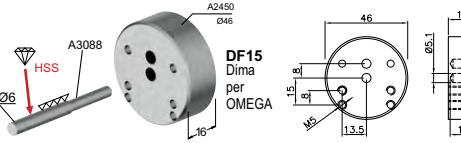
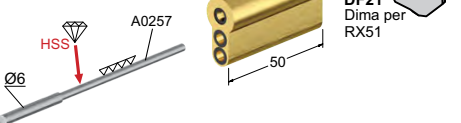
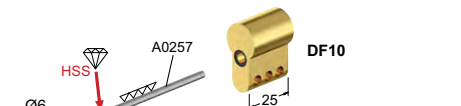
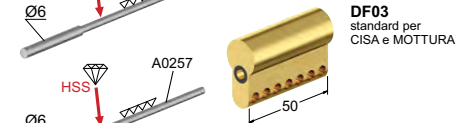

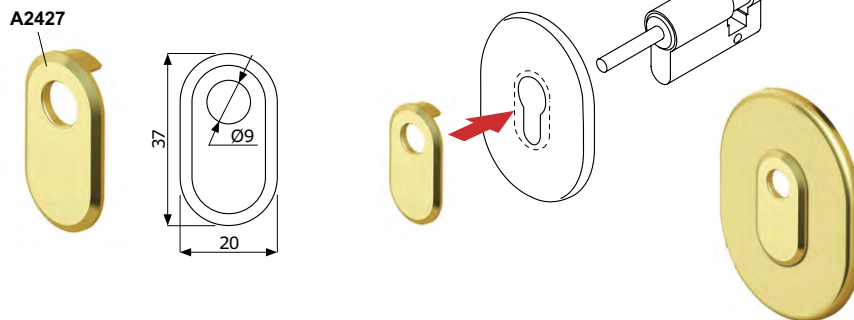
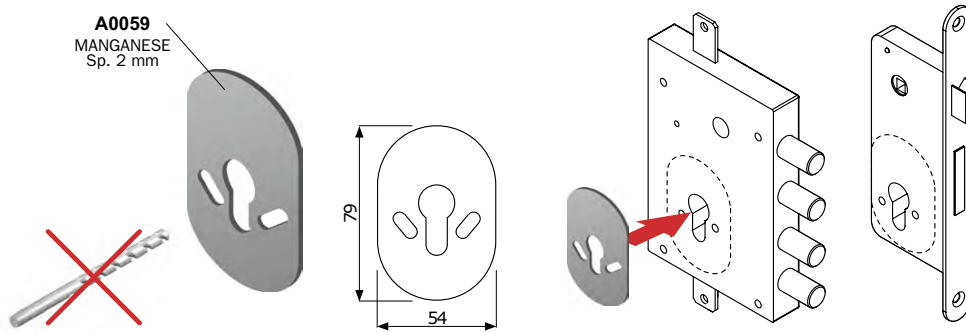
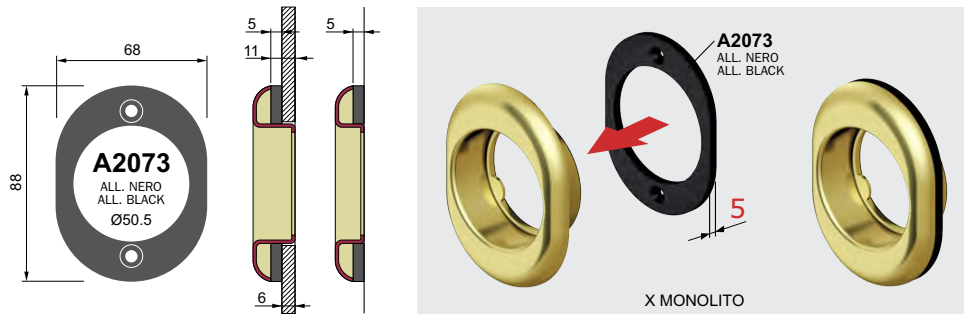

FINITURE / FINISHES

- C Cromo lucido / Bright Chrome
- B Bronzo / Bronze
- L Ottone lucido / Bright Brass
- T Cromo satinato / Satin Chrome
- N Nero / Black

Ø 50	UNIVERSAL		
	A1565 1mm		
	A1566 2mm		
	A2755 5mm		
	A2756 10mm		
	A2763 15mm		
Ø 45	A2578 2mm		
	X OMEGA		
	A3375 2mm		
Ø 44	X FIAM		
	A0592 1mm		
Ø 42	A0591 2mm		
	X TOTOR		
Ø 40	A3185 5mm		
	X ESETY X ATRA X CR		
	A1063 1mm		
	A1056 2mm		

